

SIEMENS

SIMATIC

Industrial PC SIMATIC IPC547G

Operating Instructions

Preface

Overview

1

Safety instructions

2

Installing and connecting the device

3

Commissioning the device

4

Expanded device functions

5

Expanding and assigning parameters to the device

6

Device maintenance and repair

7

Technical specifications

8

Technical support

A

List of abbreviations

B

Markings and symbols

C

Legal information

Warning notice system

This manual contains notices you have to observe in order to ensure your personal safety, as well as to prevent damage to property. The notices referring to your personal safety are highlighted in the manual by a safety alert symbol, notices referring only to property damage have no safety alert symbol. These notices shown below are graded according to the degree of danger.

⚠ DANGER
indicates that death or severe personal injury will result if proper precautions are not taken.
⚠ WARNING
indicates that death or severe personal injury may result if proper precautions are not taken.
⚠ CAUTION
indicates that minor personal injury can result if proper precautions are not taken.
NOTICE
indicates that property damage can result if proper precautions are not taken.

If more than one degree of danger is present, the warning notice representing the highest degree of danger will be used. A notice warning of injury to persons with a safety alert symbol may also include a warning relating to property damage.

Qualified Personnel

The product/system described in this documentation may be operated only by **personnel qualified** for the specific task in accordance with the relevant documentation, in particular its warning notices and safety instructions. Qualified personnel are those who, based on their training and experience, are capable of identifying risks and avoiding potential hazards when working with these products/systems.

Proper use of Siemens products

Note the following:

⚠ WARNING
Siemens products may only be used for the applications described in the catalog and in the relevant technical documentation. If products and components from other manufacturers are used, these must be recommended or approved by Siemens. Proper transport, storage, installation, assembly, commissioning, operation and maintenance are required to ensure that the products operate safely and without any problems. The permissible ambient conditions must be complied with. The information in the relevant documentation must be observed.

Trademarks

All names identified by ® are registered trademarks of Siemens AG. The remaining trademarks in this publication may be trademarks whose use by third parties for their own purposes could violate the rights of the owner.

Disclaimer of Liability

We have reviewed the contents of this publication to ensure consistency with the hardware and software described. Since variance cannot be precluded entirely, we cannot guarantee full consistency. However, the information in this publication is reviewed regularly and any necessary corrections are included in subsequent editions.

Preface

These operating instructions contain all the information you need for commissioning and operation of the SIMATIC IPC547G.

It is intended both for programming and testing personnel who commission the device and connect it with other units (automation systems, programming devices), as well as for service and maintenance personnel who install add-ons or carry out fault/error analyses.

Basic knowledge required

A solid background in personal computers and Microsoft operating systems is required to understand this manual. General knowledge in the field automation control engineering is recommended.

Validity of the Operating Instructions

These operating instructions are valid for all supplied versions of the SIMATIC IPC547G.

Scope of this documentation

The documentation for the SIMATIC IPC547G includes the following sections:

- Product Information "Important notes on your device"
- Quick Install Guide SIMATIC IPC547G
- SIMATIC IPC547G operating instructions in English and German

The documentation is part of the "Documentation and Drivers" DVD supplied with the product.

Refer to the corresponding user documentation for information and instructions on using software.

Conventions

The terms "PC" or "device" are sometimes used in place of the product name SIMATIC IPC547G in these operating instructions.

Figures

This document contains figures for the described device. The supplied device may differ in some details from the figures.

- Portions of the figure referenced in the text are marked with item numbers: ①, ②, ③, etc.
- Work steps within the figures are marked with process numbers according to the order in which they have to be performed: ①, ②, ③, ...

History

Currently released versions of these operating instructions:

Version	Comments
05/2016	First edition

Table of contents

	Preface	3
1	Overview.....	9
1.1	Product description	9
1.1.1	Scope of application.....	9
1.1.2	Highlights	10
1.1.3	Features	11
1.2	Device configuration	14
1.2.1	Interfaces	17
1.2.2	Operator controls	19
1.2.3	Status displays.....	21
1.3	Accessories.....	23
2	Safety instructions.....	25
2.1	General safety instructions	25
2.2	Notes on use.....	29
3	Installing and connecting the device	31
3.1	Preparing for installation	31
3.1.1	Checking the delivery package.....	31
3.1.2	Device identification data.....	32
3.2	Mounting the device.....	34
3.2.1	Installation guidelines.....	34
3.2.2	Mounting location and position	35
3.3	Connecting the device	36
3.3.1	Connection information	36
3.3.2	Connection of equipotential bonding line.....	38
3.3.3	Connecting the power supply	39
3.3.4	Connecting peripheral equipment.....	42
3.3.5	Securing the cables	43
3.3.6	Connecting the device to networks.....	43
3.3.7	Multi-monitoring	44
4	Commissioning the device	45
4.1	General information on commissioning	45
4.2	Switching on the device	45
4.3	Automatic switching on of the device.....	46
4.4	Notes on various device configurations	46
4.4.1	DVD burner drive	46
4.4.2	Hard disks in removable tray	47
4.4.3	System with two drives	49
4.4.4	RAID systems	50

4.4.4.1	Manage RAID system	50
4.4.4.2	RAID1 system	51
4.4.4.3	RAID5 system	51
4.4.4.4	RAID system with hot spare drive	51
4.5	Windows Action Center	52
4.6	Switching off the device	53
5	Expanded device functions	55
5.1	Monitoring functions	55
5.1.1	Temperature monitoring and temperature display	56
5.1.2	Fan monitoring	56
5.1.3	Watchdog (WD).....	57
5.1.4	Battery monitoring	58
5.1.5	Drive monitoring	58
5.2	Active Management Technology (AMT)	59
5.3	Trusted Platform Module (TPM).....	60
6	Expanding and assigning parameters to the device	61
6.1	Information on expansions	61
6.1.1	Drives in the standard enclosure	62
6.1.1.1	Permissible expansion for temperature range 0 to 35 °C.....	63
6.1.1.2	Permissible expansion for temperature range 0 to 40 °C.....	65
6.2	Opening the front door	67
6.3	Open the device	67
6.4	Memory expansion.....	68
6.5	Installing expansion cards.....	69
6.6	Drives	71
6.6.1	Overview of drives.....	71
6.6.2	Removing and installing a 3.5"/2.5" drive in drive cage type B	71
6.6.3	Removing and installing the hard disk or SSD in the removable tray.....	74
6.6.4	Hard disk or SSD, device with drive cage type A	75
6.6.4.1	Installing a hard disk drive or SSD in slot 0 to 2	76
6.6.4.2	Installing a hard disk or SSD in slot 3	78
6.6.4.3	Installing and replacing the internal hard disk or SSD on the side wall	79
6.6.5	Replacing a defective hard disk drive in the RAID system	81
6.6.6	Inserting the 5.25" drive in the drive cage type B	84
6.6.7	Removing and installing a DVD drive	87
7	Device maintenance and repair	89
7.1	Repair information.....	89
7.2	Maintenance.....	90
7.2.1	Maintenance intervals	90
7.2.2	Remove the fan cover	90
7.2.3	Replacing filters.....	91
7.3	Manage onboard RAID system.....	92
7.3.1	Example for a RAID1 system during the boot phase of the system	92
7.3.2	Example for a RAID5 system during the boot phase of the system	92

7.3.3	RAID software	93
7.3.4	Checking the status of the RAID system	93
7.3.5	Displaying a defective hard disk of a RAID system in the RAID software	94
7.3.6	Special feature: Replacing hard disk in the RAID system when switched off	95
7.3.7	Integrating a new hard disk drive in the RAID system	95
7.3.8	Integrating a hot spare hard disk drive in the RAID system	98
7.4	Removing and installing hardware	99
7.4.1	Removing the device fan	99
7.4.1.1	Changing the front fan	99
7.4.1.2	Change the fan on drive cage type A	101
7.4.2	Replacing the backup battery	102
7.4.3	Removing the power supply	103
7.4.4	Removing module of the redundant power supply	104
7.4.5	Removing the redundant power supply	105
7.4.6	Removing the motherboard	106
7.4.7	Replacing the processor	107
7.4.8	Replace the adapter module for the removable tray	109
7.4.9	Changing drives	110
7.5	Installing the software	111
7.5.1	Sources for installation of the operating system	111
7.5.2	Updating the operating system	111
7.5.3	Installing drivers and software	112
7.5.4	Installing Windows	113
7.5.5	Partitions in the factory state	118
7.5.6	Setting up the language selection using the Multilanguage User Interface (MUI)	119
7.5.7	Restoring the delivery state	120
7.5.8	Installing onboard RAID controller software	122
7.5.9	Updating USB drivers	122
7.5.10	Backing up data and changing partitions at a later time	123
7.6	Recycling and disposal	123
8	Technical specifications	125
8.1	Certificates and approvals	125
8.2	Directives and declarations	126
8.2.1	CE marking	126
8.2.2	ESD guideline	127
8.3	Dimension drawings	129
8.3.1	Dimension drawing of the device	129
8.3.2	Dimension drawing of the expansion cards	130
8.3.3	Dimension drawing of the telescope rails	130
8.4	Technical specifications	131
8.4.1	General technical specifications	131
8.4.2	Current and power requirements	138
8.4.3	AC power supply	139
8.4.4	AC power supply, redundant	140
8.4.5	Technical specifications of the telescopic rails	140
8.5	Hardware description	141
8.5.1	Motherboard	141
8.5.2	System resources	141

8.5.3	Interrupt assignment	142
8.6	BIOS description	144
8.7	Active Management Technology (AMT)	146
8.7.1	AMT basics	146
8.7.2	Overview of AMT	147
8.7.3	Activate AMT	147
8.7.4	Advanced settings	148
8.7.5	Reset AMT with Unconfigure ME	149
8.7.6	Determining the network address	149
8.7.7	Forcing user consent	150
8.8	Assignment of expansion interface to the software in the TIA Portal (CP assignment)	150
A	Technical support	151
A.1	Service and support	151
A.2	Troubleshooting	152
A.3	RAID system and device startup	154
A.4	Notes on the use of expansion cards	155
B	List of abbreviations	157
C	Markings and symbols	161
C.1	Overview	161
C.2	Safety	161
C.3	Operator controls	161
C.4	Interfaces	162
	Glossary	163
	Index	169

Overview

1.1 Product description

Note

Depending on the configuration ordered the features and illustrations described in this manual may differ from the features of your device.

The SIMATIC IPC547G is a powerful industrial PC in 19" rack format design (4 HE). It is perfectly suited for high-performance industrial PC applications.

- Maximum performance
- Attractive price

Device with standard enclosure (enclosure depth 446 mm)



1.1.1 Scope of application

The SIMATIC IPC offers system integrators, cabinet designers, system engineers and machine designers a 19" rack PC platform for high-performance applications and IT applications on the control and cell level for:

- Process and visualization applications
- Industrial image processing
- Quality assurance and monitoring tasks
- Measurement, control and rule-based tasks
- Data acquisition and management

The SIMATIC IPC has CE certification for use in the industrial sector as well as in residential and commercial areas and small businesses. In addition to the industrial applications, therefore, it can also be used in building automation or in public facilities.

1.1.2 Highlights

The latest PC technology

- State-of-the-art Intel® technology, 6th Generation Intel® Core™ i processors
- Maximum performance and scalability, independent of the enclosure version
- Expansion card slots
2 × PCIe x16, 1 × PCIe x8, 2 × PCIe x4, 2 × PCI
- Enterprise hard disks (HDD) in RAID configurations

Industrial compatibility

- Independent industrial product design
- Dust protection
- Service-friendly equipment design
- CE certification for industrial and office use
- Transport safety for expansion cards
- Monitoring functions

Security of investment

- Guaranteed spare parts availability for at least 3 years

High system availability

- SIMATIC PC DiagMonitor – PC diagnostics and message software via OPC/SNMP/LAN
- Preventative data backup with the SIMATIC IPC Image & Partition Creator
- RAID* configurations: RAID controller onboard
- RAID1* – Disk mirroring on two drives, "hot swap" in connection with removable tray
- RAID5** – Striping with parity on three drives, "hot swap" in connection with removable tray
- Redundant power supply

* depending on the motherboard variant

* depending on the motherboard variant and enclosure variant

1.1.3 Features

Note

Please take note of the version ordered

Depending on the configuration ordered the features and illustrations described in this manual may differ from the features of your device.



Basic data

Design	<ul style="list-style-type: none"> • 19" rack, 4 HU, 446 mm deep • Rugged full-metal enclosure, painted outside (optional) and coated inside (blue-chromated) • Prepared for mounting telescopic rails • Horizontal and vertical mounting position is possible • Tower setup with tower kit • Lockable front door as access protection
Enclosure	<ul style="list-style-type: none"> • Dust protection by means of overpressure ventilation using bearing seated front fan through filter • Card retainers secure PC expansion cards for transport (vibration, shock)
7 slots for expansion modules	<p>You can use expansion cards with a length of up to 312 mm.</p> <p>Motherboard D3446:</p> <ul style="list-style-type: none"> • 2 × PCI • 1 × PCIe x4* (4 lanes); Gen 3.0 • 1 × PCIe x4* (1 lane); Gen 3.0 • 1 × PCIe x16 (4 lanes); Gen 3.0 • 1 × PCIe x8* (1 lane); Gen 3.0 • 1 × PCIe x16; Gen 3.0 <p>Motherboard D3445:</p> <ul style="list-style-type: none"> • 2 × PCI • 2 × PCIe x4* (1 lane); Gen 2.0 • 1 × PCIe x16 (1 lane); Gen 2.0 • 1 × PCIe x8* (1 lane); Gen 2.0 • 1 × PCIe x16; Gen 3.0 <p>* open direct plug sockets</p>
Power supply	100V to 240V AC
Power supply, redundant	2 × 100V to 240V AC
Interfaces	See section "Interfaces (Page 17)".

1.1 Product description

Drive bays	<ul style="list-style-type: none"> • On the front: <ul style="list-style-type: none"> – 4 × slimline removable trays in the drive cage type A or – 1 × 5.25" with mounting bars and 3 × slimline removable trays in the drive cage type A or – 3 × 5.25"/3.5" with mounting bars in drive cage type B and in each case <ul style="list-style-type: none"> – 1 × slimline format for DVD burner • Internal: <ul style="list-style-type: none"> – 2 × 3.5" with cage for internal mounting of drive
------------	--

Installation options of drives in a standard enclosure

	Drive cage type A	Drive cage type B
Basic design		
Possible drive bays	<ul style="list-style-type: none"> • 4 × 3.5"/2.5" ② or • 1 × 5.25" ① + 3 × 3.5"/2.5" ② and <ul style="list-style-type: none"> • 1 × 9.5 mm slimline ODD ③ 	<ul style="list-style-type: none"> • 3 × 3.5"/2.5" ② (max. 2 are released) or • 3 × 5.25" ① and <ul style="list-style-type: none"> • 1 × 9.5 mm slimline ODD ③
of which drives in the removable tray	4	0
of which drives for internal, robust installation	0	2 (3.5"/2.5")

Monitoring and safety functions

Temperature	<ul style="list-style-type: none"> Violation of high/low limits of permitted operating temperature
Fan	<ul style="list-style-type: none"> Speed monitoring
Watchdog	<ul style="list-style-type: none"> Monitoring functions for program execution Monitoring time can be parameterized in software Restart can be parameterized in the event of a fault Warnings can be analyzed by application program (local, via LAN)
Status displays, front	<ul style="list-style-type: none"> POWER – internal power supply available, PC switched on HDD – access to hard disk drive / SSD TEMP – temperature status FAN – fan status HDD alarm – hard disk drive / SSD status in connection with RAID and monitoring software
Status displays, rear	<ul style="list-style-type: none"> Power supply, redundant

Operating system

Operating system	<ul style="list-style-type: none"> Without Pre-installed, included on Restore DVD: <ul style="list-style-type: none"> Microsoft Windows 7 Ultimate, 64-bit, MUI ¹ Microsoft Windows Server 2008 R2, 64-bit including 5 clients, MUI ¹ Microsoft Windows Server 2012 R2, 64-bit including 5 clients, MUI ¹ Microsoft Windows 10 IoT Enterprise 2015 LTSC ¹
------------------	--

¹ 5 languages (English, German, French, Italian, Spanish)

Operating system languages

The following languages for the operating system can be installed at a later time:

Language	Windows Server 2008 R2 ¹	Windows Server 2012 R2 ¹	Windows 7 64-bit ¹ Windows 10 ²
German (Germany)	X	X	X
English (United States)	X	X	X
French (France)	X	X	X
Italian (Italy)	X	X	X
Spanish (Spain)	X	X	X
Japanese (Japan)	X	X	X
Korean (Korea)	-	X	X
Russian (Russia)	X	X	X
Chinese (PRC)	X	X	X
Chinese (Hong Kong S.A.R.)	X	X	X
Chinese (Taiwan)	X	X	X

¹ The languages can be installed at a later time from the Recovery DVD.

² The languages can be installed at a later time from the Restore DVD.

Optional software

SIMATIC IPC DiagMonitor V4.5.2 or higher	Software tool for monitoring local and remote SIMATIC PCs: <ul style="list-style-type: none">• Watchdog• Temperature• Fan• Battery• Hard disk drive / SSD monitoring (SMART, RAID status ¹)
SIMATIC IPC Image & Partition Creator V3.4.2 or higher	Software tool for local data backup and setting up of the hard disks.

¹ A hot-spare drive of a RAID system is not displayed.

1.2 Device configuration

Device front



Example with drive cage type A

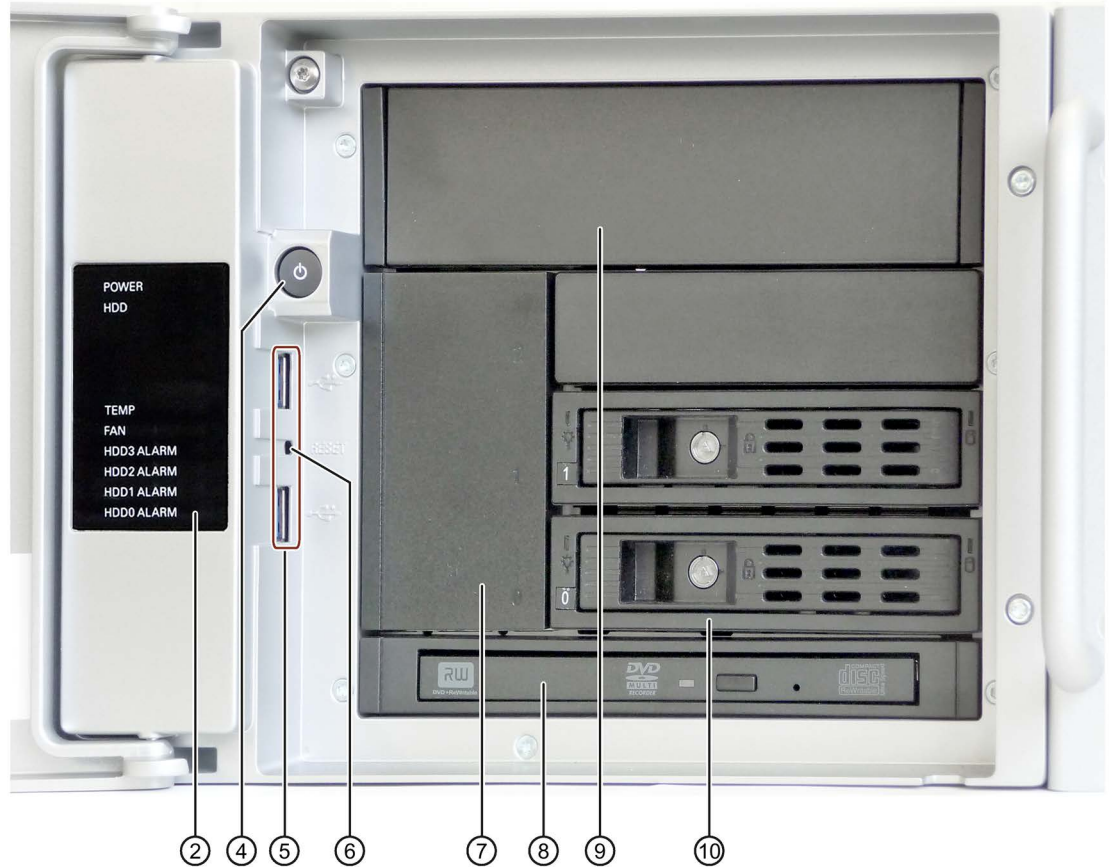

- | | | |
|---|------------------------|--|
| ① | Fan cover | Fan cover with openings for ventilation of the device |
| ② | Status displays | See section "Status displays (Page 21)" |
| ③ | Front door | Lockable front door that provides protection against unauthorized access. Connect the front door with the lock ⑪ during normal operation. |
| ④ | On/off button | See section "Operator controls (Page 19)" |
| ⑤ | 2 × USB 3.0 | Connections for USB devices, backward compatible with USB 2.0/1.1 |
| ⑥ | Reset button | See section "Operator controls (Page 19)" |
| ⑦ | Cover | Covers the removable rack unit slot or the fixing screws of the drives and is taken off for removing and installing the internal hard disks. |
| ⑧ | Optical drive | DVD burner drive |
| ⑨ | 5.25" slot | 1 removable tray with drives (HDD or SSD) or 5.25" drive |
| ⑩ | 1 to 3 removable trays | Depending on configuration, 1 to 3 removable trays with drives (HDD or SSD) |
| ⑪ | Lock | Access protection of front door: <ul style="list-style-type: none"> • Key vertical: open • Key horizontal: closed |

Rear of the device

Device with motherboard D3446-S

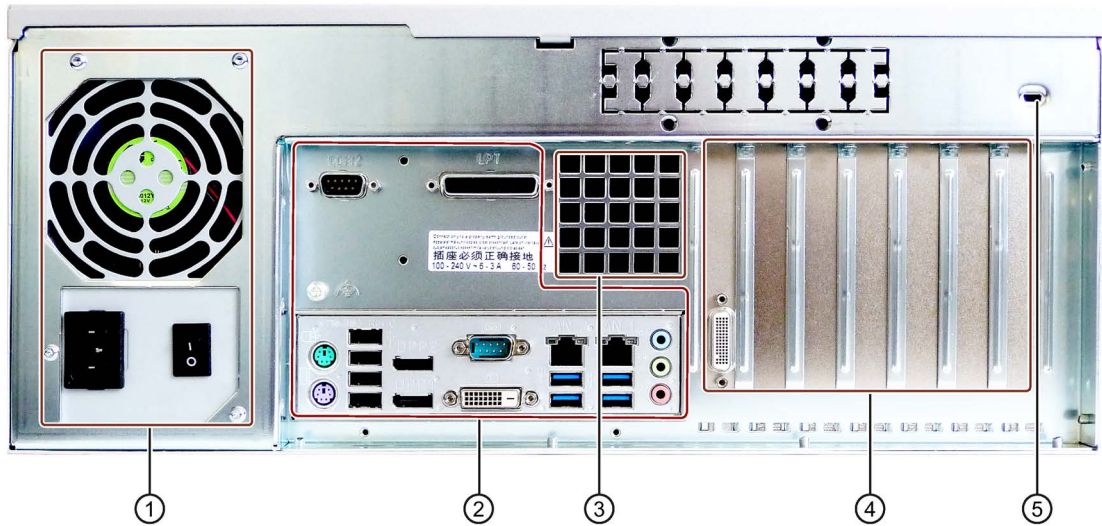

Device with motherboard D3445-S

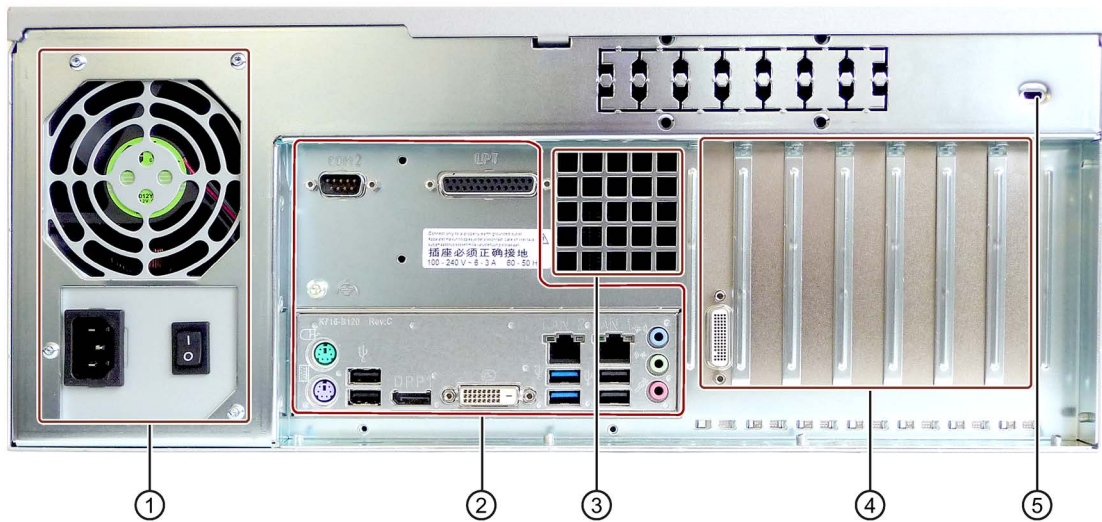

- | | |
|--|--|
| <ul style="list-style-type: none"> ① Power supply ② Interfaces ③ Air outlet ④ Expansion card slots ⑤ Kensington | <ul style="list-style-type: none"> See section "Interfaces (Page 17)", power supply connection See section "Interfaces (Page 17)" <ul style="list-style-type: none"> • 2 × PCI • 2 × PCIe x16 • 1 × PCIe x8 • 2 × PCIe x4 prepared for Kensington lock |
|--|--|

1.2.1 Interfaces

Interfaces

Device with motherboard D3446-S

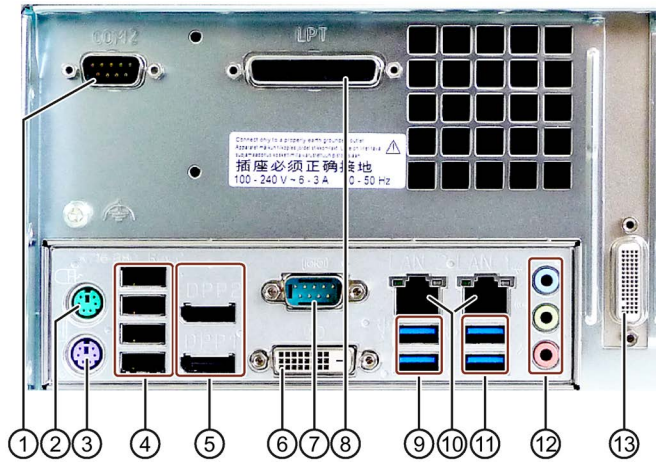

Device with motherboard D3445-S

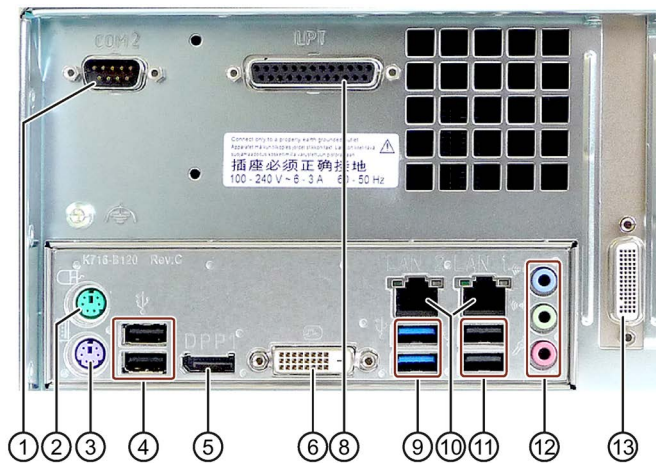

- | | | |
|---|----------|---|
| ① | COM2 | Serial interface 2 (V.24), 9-pin D-sub socket (optional) |
| ② | Mouse | Connection for a PS/2 mouse |
| ③ | Keyboard | Connection for a PS/2 keyboard |
| ④ | USB 2.0 | Connections for USB devices |
| ⑤ | DPP | Connection for monitors with DisplayPort interface or VGA via DP/VGA adapter or DVI-D via DP/DVD-D adapter (optional) |
| ⑥ | DVI-D | Connection for monitor with DVI interface |
| ⑦ | COM1 | Serial interface 1 (V.24), 9-pin D-sub socket |

Power supply connections

In the following figure the AC connections of the power supply are marked, on the left for devices with a single power supply and on the right with redundant power supply:



NOTICE

Incompatible enclosure

Conversion from one power supply type to another is not possible.

1.2.2 Operator controls

WARNING

Risk of electric shock

The on/off button and on/off switch do not fully disconnect the device from the mains. If the device is switched off with the on/off switch, there remains a risk of electric shock and fire hazard, for example, if the device or connection cables are damaged or if the device is used improperly.

Always fully disconnect the device from the mains voltage as follows before performing work on the device or when the device will not be used over an extended period of time:

- Pull the power plug on the rear of the device.
- For control cabinet mounting:
Take additional precautions, for example, by using a circuit breaker.

Read the information in section "Switching off the device (Page 53)".

On/Off switch and alarm reset button

The following figures show the location of the on/off switch on the rear of the device for devices with simple or redundant power supply. The alarm reset button is only available for devices with redundant power supply.

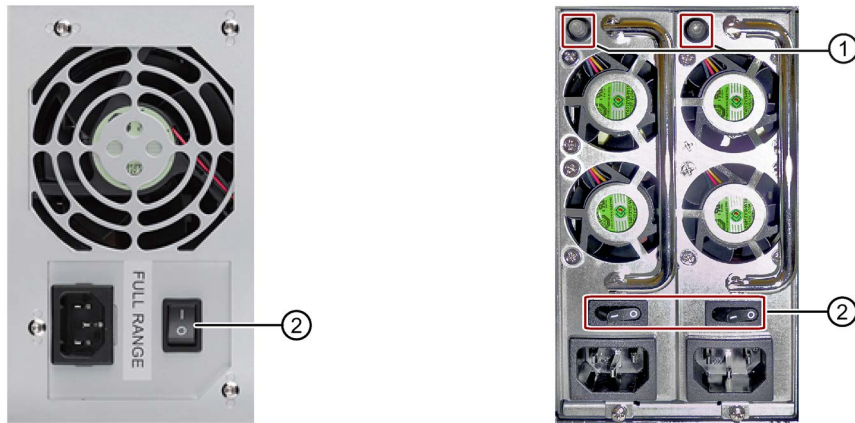

- ① Alarm reset button for switching off the warning signal of the redundant power supply
- ② On/off switch

On/off switch and reset button

The On/off button ① and the reset button ② are located on the front of the device behind the front door. The On/off button starts and shuts down the operating system. The reset button is for the emergency when the device can no longer be operated.

You can find additional information in the chapters "Switching on the device (Page 45)" and "Switching off the device (Page 53)."

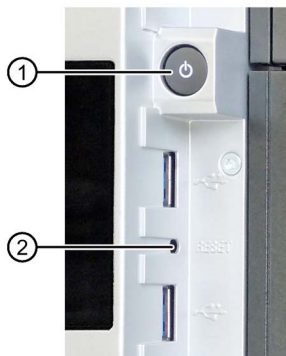

- ① On/off button
- ② Reset button for emergencies

1.2.3 Status displays

Front status displays

The status displays integrated in the front door provide information on the status of the device components listed in the following table.

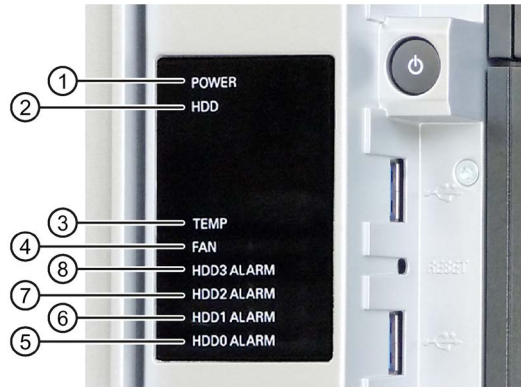

Item	Status display	Meaning	LED	Description
①	POWER	Operating mode of the PC	OFF	Switched off or disconnected from the mains
			YELLOW	Idle state or shut down
			YELLOW lit GREEN flashing	Windows is in Standby mode
			GREEN	PC in operation
②	HDD	Access to hard disk	OFF	No access
			GREEN	Access
③	TEMP	Temperature status	OFF	No error
			RED flashing	Possible causes: <ul style="list-style-type: none"> • CPU temperature is critical • Device temperature is critical
④	FAN	Fan status	OFF	No error
			RED flashing	Possible causes: <ul style="list-style-type: none"> • CPU heat sink fan fault • Front fan faulty • Fan on drive cage type A faulty • Fan of simple power supply faulty (non-redundant power supply)
⑤ ⑥ ⑦ ⑧	HDD0 Alarm HDD1 Alarm HDD2 Alarm HDD3 Alarm	HDD alarm in connection with RAID and monitoring software with motherboard D3446-S only	OFF	RAID is OK
			A RED LED is lit up	The associated drive is not OK
			All RED LEDs are flashing	RAID synchronization running, RAID is not OK The hard disk newly integrated in case of error is synchronized with an existing hard disk.
			All RED LEDs are lit up	RAID is not OK The faulty drive could not be localized by the monitoring software. It may be possible to detect the defective drive with the RAID software, see chapter "RAID1 system (Page 51)", "RAID5 system (Page 51)" or "RAID system with hot spare drive (Page 51)".

Rear status displays

The following status displays are located on the rear of the device:

- LEDs of the Ethernet interface

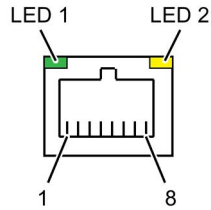

Status display	Meaning	Status	Meaning of the status
LED 1 ¹	Connection status	OFF	<ul style="list-style-type: none"> No cable connected Cable disabled Interface disabled
		GREEN	<ul style="list-style-type: none"> Active cable connected
		GREEN, flashing	<ul style="list-style-type: none"> Data transfer active
LED 2 ¹	Data transmission rate	OFF	<ul style="list-style-type: none"> 10 Mbps
		GREEN	<ul style="list-style-type: none"> 100 Mbps
		YELLOW	<ul style="list-style-type: none"> 1000 Mbps

¹ The Ethernet ports are numbered on the enclosure to identify them clearly. The numbering by the operating system may deviate from this.

- Redundant power supply





Status display	Meaning	Status	Meaning of the status
Status LED (see marking)	Status of the power supply module	OFF	<ul style="list-style-type: none"> Module is out of service, no redundancy in effect.
		GREEN	<ul style="list-style-type: none"> The module is in operation and functioning. Redundancy is in effect when both modules are operating.
		RED	<ul style="list-style-type: none"> Module failed, no redundancy in effect.

¹ The Ethernet ports are numbered on the enclosure to identify them clearly. The numbering by the operating system may deviate from this.



1.3 Accessories

Accessories are available for your device. These are not included in the scope of delivery. Information on available accessories is listed in the table below and on the Internet at the following addresses:

- IPC expansion components (http://www.automation.siemens.com/mcms/pc-based-automation/en/industrial-pc/expansion_components_accessories)
- Industry Mall (<https://mall.industry.siemens.com>)

Name	Description	Device with standard enclosure	Article number / MLFB
Retainer for locking the internal USB interface	<p>The retainer is a mechanical safety device for the internal USB interface. It optimizes the protection of an internal USB memory stick against loads caused by vibration and shock during transportation or operation.</p> <p>This increases the reliability and operational safety of the device.</p>	x	<p>6ES7648-1AA00-0XK0</p> 
Tower Kit	<p>You can use the Tower Kit to convert the device into an industrial Tower PC. This step expands the operating range beyond the control cabinet.</p> <p>Components of the Tower Kit:</p> <ul style="list-style-type: none"> • Cover • Feet • Accessories: Screws and rubber feet 	x	<p>6ES7648-1AA01-0XC0 (standard enclosure)</p> 

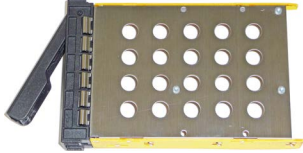
1.3 Accessories

Name	Description	Device with standard enclosure	Article number / MLFB
Low profile removable rack unit	<p>The removable tray makes for quick and simple replacement of a 2.5" or 3.5" drive without having to open the device or remove it from the control cabinet. The result is the following advantages for service and maintenance, data backup and data transfer:</p> <ul style="list-style-type: none"> • Replacement of a failed hard disk in operation ("hot-swap") • Downloading different system states or operating systems from different hard drives during a short period of time. • Simplified data backup by copying, for example, to a backup hard drive. • Simple transportation of backup data • Separate data storage and archiving possible 	x	<p>6ES7648-0EH00-1BA0</p>  <p>Similar to figure</p>
DP / DVI adapter	Graphics adapter cable, DisplayPort to DVI	x	<p>6ES7648-3AF00-0XA0</p> 
DP / VGA adapter	Graphics adapter cable, DisplayPort to VGA	x	<p>6ES7648-3AG00-0XA0</p> 

Safety instructions

2.1 General safety instructions

Fully disconnecting the device from mains voltage

 WARNING
Risk of fire and electric shock
The on/off button and on/off switch do not fully disconnect the device from the mains. If the device is switched off with the on/off switch, there remains a risk of electric shock and fire hazard, for example, if the device or connection cables are damaged or if the device is used improperly.
Always fully disconnect the device from the mains voltage as follows before performing work on the device or when the device will not be used over an extended period of time.
<ul style="list-style-type: none">• If the device was not mounted in a control cabinet: Shut down the operating system and pull the power plug on the rear of the device.• If the device was mounted in a control cabinet: Shut down the operating system and switch the AC circuit breaker to "Off".• Properly connect the device to a protective conductor.

Devices in the control cabinet

 WARNING
Life-threatening voltages are present with an open control cabinet
When you open the control cabinet, some areas or components may be carrying life-threatening voltages.
If you touch these areas or components, you may be killed by electric shock.
Switch off the power supply to the cabinet before opening it.

System expansions

NOTICE

Damage to the device, machine or plant due to device and system expansions

Device and system expansions may contain faults and affect the entire device, machine or plant.

Device and system expansions may violate safety rules and regulations regarding radio interference suppression. If you install or replace device or system expansions and damage your device, the warranty is voided.

Note the following:

- Only install device or system expansions designed for this device. Contact your technical support team or the point of sale to find out which device and system expansions are suitable for installation.
- Please observe the information on electromagnetic compatibility in the technical specifications.



CAUTION

Fire hazard due to overheating of the device

Expansion cards generate additional heat. The device can overheat or cause a fire.

- Observe the safety and installation instructions for the expansion cards.
- Observe the max. permissible power consumption values for the device in the section "Technical specifications".

Battery



WARNING

Risk of explosion and release of harmful substances

Improper handling of lithium batteries can result in an explosion of the batteries.

Explosion of lithium batteries and the released pollutants can cause serious physical injury. Damaged batteries jeopardize the function of the device.

Note the following when handling lithium batteries:

- Replace used batteries in good time; see the section "Replacing the backup battery" in the section "Device maintenance and repair".
- Replace the lithium battery only with an identical battery or types recommended by the manufacturer (order no.: A5E00369854).
- Do not throw lithium batteries into fire, do not solder on the cell body, do not recharge, do not open, do not short-circuit, do not reverse polarity, do not heat above 100°C and protect from direct sunlight, moisture and condensation.

Strong high-frequency radiation

NOTICE

Observe immunity to RF radiation

The device has an increased immunity to RF radiation according to the specifications on electromagnetic compatibility in the technical specifications.

Radiation exposure in excess of the specified immunity limits can impair device functions, result in malfunctions and therefore injuries or damages.

Read the information on immunity to RF radiation in the technical specifications.

ESD directive



Electrostatic sensitive devices can be labeled with an appropriate symbol.

NOTICE

Electrostatic sensitive devices (ESD)

When you touch electrostatic sensitive components, you can destroy them through voltages that are far below the human perception threshold.

If you work with components that can be destroyed by electrostatic discharge, observe the ESD directive in the technical specifications.

Industrial Security

Siemens offers products and solutions with Industrial Security functions that support the safe operation of equipment, solutions, machines, devices and/or networks. They are important components in a comprehensive Industrial Security concept. As a result the products and solutions from Siemens are constantly evolving. Siemens recommends obtaining regular information regarding product updates.

For safe operation of Siemens products and solutions appropriate protective measures (e.g., cell protection concept) must be taken and each component must be integrated in a comprehensive Industrial Security concept, which corresponds with the current state of technology. The products of other manufacturers need to be taken into consideration if they are also used. You can find addition information on Industrial Security under (<http://www.siemens.com/industrialsecurity>).

Sign up for our product-specific newsletter to receive the latest information on product updates. For more information, see under (<https://support.industry.siemens.com>).

Disclaimer for third-party software updates

This product includes third-party software. Siemens AG only provides a warranty for updates/patches of the third-party software, if these have been distributed as part of a Siemens software update service contract or officially released by Siemens AG. Otherwise, updates/patches are undertaken at your own risk. You can find more information about our Software Update Service offer on the Internet at Software Update Service (<http://www.automation.siemens.com/mcms/automation-software/en/software-update-service>).

Notes on protecting administrator accounts

A user with administrator privileges has extensive access and manipulation options in the system.

Therefore, ensure there are adequate safeguards for protecting the administrator accounts to prevent unauthorized changes. To do this, use secure passwords and a standard user account for normal operation. Other measures, such as the use of security policies, should be applied as needed.

Access protection

 CAUTION
Protection against access by unauthorized persons
An unauthorized user can operate the device incorrectly and bypass logon by restarting the device.
Operator actions by unauthorized persons jeopardize operational reliability.
Take the following safety precautions:
<ul style="list-style-type: none">• Lock the front door and the removable trays.• Do not use keyboards with an on/off button (Power button).• If the device has a on/off button, assign the parameters of the function of the on/off button to meet your requirements under Windows. You can find the settings in the "Power Options" menu.

Headphones

 CAUTION
Impaired hearing due to excessive sound pressure
The setting of the volume and the equalizer can increase the sound pressure in the headphones. Other factors not mentioned by the manufacturer can also influence the sound pressure, for example, the operating system, equalizer software, firmware and driver.
Excessive sound pressure from headphones can result in impaired hearing or even loss of hearing.
Set the volume control and equalizer to the lowest value before you put on the headphones. Keep checking the volume control setting. Only use headphones and software approved by the manufacturer.

2.2 Notes on use

NOTICE**Possible functional restrictions in case of non-validated plant operation**

The device is tested and certified on the basis of the technical standards. In rare cases, functional restrictions can occur during plant operation.

Validate the correct functioning of the plant to avoid functional restrictions.

NOTICE**Rack-mount instructions**

A) Elevated Operating Ambient - If installed in a closed or multi-unit rack, the operating ambient temperature of the rack environment may be greater than the room ambient. Therefore consideration should be given to installing the equipment in an environment compatible with the maximum ambient temperature (T_{ma}) specified by the manufacturer.

B) Reduced Air Flow - Installation of the equipment in a rack should be such that the amount of air flow required for safe operation of the equipment is not compromised.

C) Mechanical Loading - Mounting of the equipment in the rack should be such that a hazardous condition is not achieved due to uneven mechanical loading.

D) Circuit Overloading - Consideration should be given to the connection of the equipment to the supply circuit and the effect that overloading of the circuits might have on overcurrent protection and supply wiring. Appropriate consideration of equipment nameplate ratings should be used when addressing this concern.

E) Reliable Earthing - Reliable earthing of rack-mounted equipment should be maintained. Particular attention should be given to supply connections other than direct connections to the branch circuit (e. g. use of power strips).

Note**Use in an industrial environment without additional protective measures**

This device was designed for use in a normal industrial environment according to IEC 60721-3-3.

Ambient and environmental conditions

 **WARNING**

Voided approvals

If the following conditions for system installation are not observed, approvals in accordance with UL 60950-1 and EN 60950-1 are rendered void and there is a risk of overheating and personal injury.

NOTICE

Damage to the device due to environmental conditions

Ambient conditions for which the device is not suitable can cause faults or damage the device.

Note the following:

- Operate the device only in closed rooms. Failure to comply nullifies the warranty.
- Operate the device only in accordance with the ambient conditions.
- Observe the permitted mounting positions of the device.

When you plan your project, you should make allowances for:

- Climatic and mechanical environmental conditions defined in the "General technical data" chapter of the operating instructions.
- This device was designed for use in a normal industrial environment. SIMATIC Rack PCs may not be operated in severe environments which are subject to caustic vapors or gases without taking additional protective measures (such as the provision of clean air.)
- Avoid extreme ambient conditions as far as possible, for example, heat.
- Do not expose the device to direct sunlight or other powerful light sources.
- Install the device in such a way that it poses no danger, for example, by falling over.
- Always maintain a minimum clearance of 50 mm to the area of the ventilation slots in order to ensure adequate ventilation of the PC.
- Do not cover the ventilation slots of the enclosure. There must be distance of at least 5 cm at the back of the device, depending on wiring.
- The device meets the requirements for fire protection enclosures in accordance with EN 60950-1. You can therefore install it without additional fire protection enclosure.
- The connected or built-in peripherals should not introduce a counter emf in excess of 0.5 V into the device.
- The device conforms to protection class IP30 at the front panel. Ensure that the installation opening for the device is splash-proof in areas which may be subject to splash water.

Installing and connecting the device

3.1 Preparing for installation

3.1.1 Checking the delivery package

Procedure

1. When accepting a delivery, please check the packaging for visible transport damage.
2. If any transport damage is present at the time of delivery, lodge a complaint at the shipping company in charge. Have the shipper confirm the transport damage immediately.
3. Unpack the device at its installation location.
4. Keep the original packaging in case you have to transport the unit again.

Note

Damage to the device during transport and storage

If a device is transported or stored without packaging, shocks, vibrations, pressure and moisture may impact the unprotected unit. Damaged packaging indicates that ambient conditions have already had a massive impact on the device and it may be damaged.

This may cause the device, machine or plant to malfunction.

- Keep the original packaging.
 - Pack the device in the original packaging for transportation and storage.
-

5. Check the contents of the packaging and any accessories you may have ordered for completeness and damage.
6. Please inform the delivery service immediately if the package contents are incomplete or damaged or do not correspond with your order. Fax the enclosed form "SIMATIC IPC/PG Quality Control Report".

 WARNING
--

Electric shock and fire hazard due to damaged device

A damaged device can be under hazardous voltage and trigger a fire in the machine or plant. A damaged device has unpredictable properties and states.

Death or serious injury could occur.

Make sure that the damaged device is not inadvertently installed and put into operation. Label the damaged device and keep it locked away. Send off the device for immediate repair.

3.1 Preparing for installation

<p>NOTICE</p> <p>Damage from condensation</p> <p>If the device is subjected to low temperatures or extreme fluctuations in temperature during transportation, as is the case in cold weather, for example, moisture can build up on or inside the device (condensation).</p> <p>Moisture causes a short circuit in electrical circuits and damages the device.</p> <p>In order to prevent damage to the device, proceed as follows:</p> <ul style="list-style-type: none">• Store the device in a dry place.• Bring the device to room temperature before starting it up.• Do not expose the device to direct heat radiation from a heating device.• If condensation develops, wait approximately 12 hours or until the device is completely dry before switching it on.

- 7. Please keep the enclosed documentation in a safe place. It belongs to the device. You need the documentation when you commission the device for the first time.
- 8. Write down the identification data of the device.

3.1.2 Device identification data

The device can be clearly identified with the help of this identification data in case of repairs or loss.

The following illustrations are examples. The data of your device may differ from the data in these examples.

- Rating plate

The rating plate is located inside the front door and is shown below:

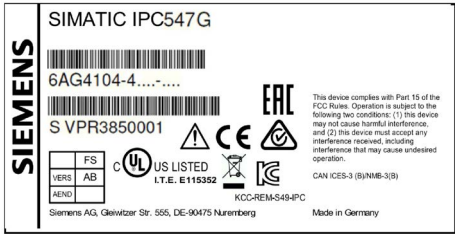

- COA label

The COA label (Certificate of Authenticity) is only provided with a pre-installed Windows operating system. Open the front door to check for the COA label.

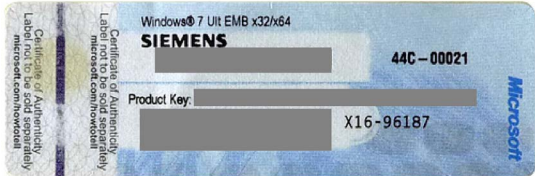

- Component label

The component label is located inside the front door.

SIMATIC IPC547G		Slot 1
Order No.: 6AG4-104-4....-...		Slot 2
Serial No.: ...		Slot 3
Core i5 CPU ...		Slot 4
RAID1 (2x1TB ...		Slot 5
... TB DDR4 ...		Slot 6
DVD+/-RW		Slot 7
seriell (COM2) ...		
Windows Server 2008 ...		
110/230 VAC Industrie ...		
Onboard MAC-Adresses:		
Ethernet LAN 1:	000E8C8E81CE	Service & Support //www.siemens.com/asis
Ethernet LAN 2:	000E8C8E07C8	

Procedure

Identification date	Source	Value
Order number	Rating plate	6AG4104-4...
Serial number	Rating plate	
Manufacturing version	Rating plate	FS
Microsoft Windows Product Key	COA label	
Ethernet address 1, MAC address	BIOS setup > "Main" menu or: Component label	
Ethernet address 2, MAC address		

1. Copy the order number, serial number and manufacturing version in the table listed above.
2. Copy the Windows "Product Key" to the table.
3. Copy the Ethernet addresses from the component label to the table.

The Ethernet addresses can also be found in the BIOS setup (F2 key) under "Main > System Information", parameters "LAN 1: MAC Address" and "LAN 2: MAC Address".

3.2 Mounting the device

3.2.1 Installation guidelines

 **WARNING**

Danger, high voltage

A high voltage may be present in the switchgear cabinet and could cause a dangerous electric shock.

It may result in death or serious physical injury.

Isolate the power supply to the switchgear cabinet before opening it. Ensure that the power to the switchgear cabinet cannot be turned on accidentally.

NOTICE

Fire hazard

If you install the device in an unapproved mounting position or if you do not observe the ambient conditions, the device can overheat. In this case the UL approval and conformity with the low-voltage directive (EN 60950-1:2006 and DIN EN 60950-1:2006-11) become void.

Overheating can cause a fire. Proper functioning of the device is no longer guaranteed.

Before you install the device, note the following general installation information.

Note

The device meets the requirements for fire protection enclosures in accordance with EN 60950-1. It can therefore be installed without an additional fire protection cover.

- Install the device only in one of the described permitted mounting positions.
- Provide adequate volume in the switchgear cabinet for air circulation and heat transport.
- Do not cover the ventilation slots of the device. There must be distance of at least 5 cm at the back of the device, depending on wiring.
- Ensure that the maximum air intake temperature directly in front of the air intake opening does not exceed the permitted temperature according to the technical specifications of the device. The maximum air intake temperature must be accounted for especially when sizing closed switchgear cabinets.
- Install the device in such a way that it does not pose a danger, for example, by falling over.

Note

For more details, consult the "Technical Data" in the "Ambient conditions" chapter.

3.2.2 Mounting location and position

Mounting location

The device can be installed in control cabinets and 19" rack systems.

Mounting position

The devices can be installed in the following ways:

- Mounting with mounting brackets, horizontal
- Mounting on device stands, horizontal
- Tower installation, vertical: You can order a Tower Kit for tower installation.
- Mounting on telescopic rails

When telescopic rails are used for mounting, the device can be withdrawn fully from the cabinet or rack. Note the information in section "Technical specifications of the telescopic rails (Page 140)".

CAUTION

Risk of physical injury

The device is too heavy to be mounted exclusively with the 19 inch brackets of the front panel. The device may fall down, injure people and get damaged.

Secure the device using additional measures. The mounting screws of the telescopic rails may not protrude more than 5 mm into the device.

Note

For vertical operation, mount the device on a horizontal base made of metal and secure it against falling. The following device stands are available from the Rittal company:

Rittal type TE 7000.620, Rittal type VR 5501.655, Rittal type DK 5501.655.

Please observe the instructions from the cabinet manufacturer.

Position of the mounting holes for angle brackets or telescopic rails

The dimensions for the mounting holes are listed in the chapter "Dimension drawing of the telescope rails (Page 130)".

Fastening holes for standard enclosure

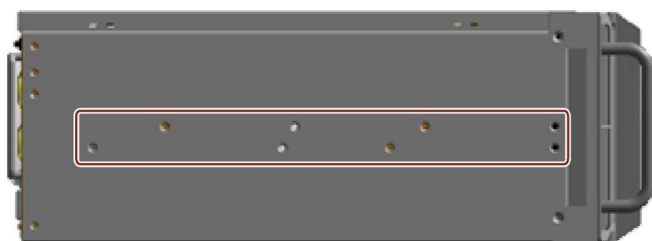

3.3 Connecting the device

3.3.1 Connection information

 **WARNING**

Risk of fire and electric shock

The on/off button and on/off switch do not fully disconnect the device from the mains. If the device is switched off with the on/off switch, there remains a risk of electric shock and fire hazard, for example, if the device or connection cables are damaged or if the device is used improperly.

Always fully disconnect the device from the mains voltage as follows before performing work on the device or when the device will not be used over an extended period of time.

- If the device was not mounted in a control cabinet: Shut down the operating system and pull the power plug on the rear of the device.
- If the device was mounted in a control cabinet: Shut down the operating system and switch the AC circuit breaker to "Off".
- Properly connect the device to a protective conductor.

 **WARNING**

Risk of lightning strikes

A lightning flash may enter the mains cables and data transmission cables and jump to a person.

Death, serious injury and burns can be caused by lightning.

Take the following precautions:

- Pull out the power plug in good time when a thunderstorm is approaching.
- Do not touch mains cables and data transmission cables during a thunderstorm.
- Keep sufficient distance from electric cables, distributors, systems, etc.

Note

Make sure that the shockproof power outlet of the building installation is freely accessible and as close as possible to the device, especially when the power plug is secured with a locking power plug latch.

⚠ WARNING**Operation only in TN networks**

The device is designed exclusively for operation on grounded power supply systems (TN networks per VDE 0100 Part 100 or IEC 60364-1). Operation with non-grounded or impedance-grounded systems is not permitted.

Rated voltage

The permitted nominal voltage of the device must conform with local mains voltage.

I/O devices**NOTICE****Fault caused by I/O devices**

The connection of I/O devices can cause faults in the device. The result may be personal injury and damage to the machine or plant. Note the following:

- Connect only I/O devices which are approved for industrial applications in accordance with EN 61000-6-2/IEC 61000-6-2.
- Non-hot-plug capable I/O devices may only be connected when the power supply to the device is switched off.

Damage through regenerative feedback

Regenerative feedback of voltage to ground by a connected or installed component can damage the device.

Connected or built-in I/Os, for example, a USB drive, are not permitted to supply any voltage to the device. Regenerative feedback is generally not permitted.

See also

Switching off the device (Page 53)

3.3.2 Connection of equipotential bonding line

A low-impedance earth connection ensures that interference signals generated by external power supply cables, signal cables or other cables to the I/O devices are safely discharged to earth.

The connection for functional earthing on a device has a large surface, makes contact over a large area and is marked with the following symbol.



Requirement

- T20 screwdriver

Procedure

1. Connect the identified connection for functional earthing via an equipotential bonding line to the equipotential bonding rail or grounding bar of the control cabinet in which the device is installed.

The minimum cross-section of the equipotential bonding line is 2.5 mm².

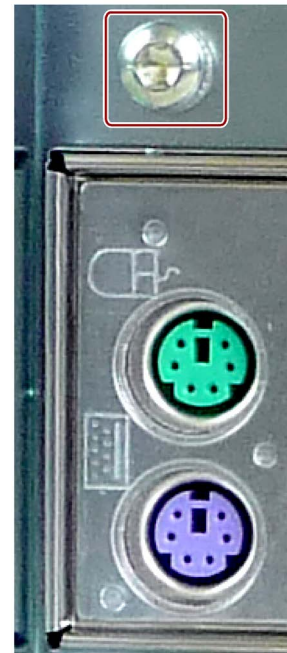

3.3.3 Connecting the power supply

Please observe before connecting

 WARNING
Injury to persons or damage to property when operated on an incorrect power supply system
If you connect the device to an unsuitable power supply, the device receives voltages and currents that are too high or too low.
Injuries to persons, malfunctions or a damage to the device can result.
Note the following information regarding the power supply system:
<ul style="list-style-type: none">• The permissible rated voltage of the device must match the local supply voltage.• Operate the device only in grounded power supply networks (TN networks in accordance with VDE 0100, Part 100 or IEC 60364-1).• Operation in non-grounded or impedance-grounded networks is not permitted.

Note**Operation with uninterruptible power supply**

An uninterruptible AC power supply (UPS) must be used when this device is operated with a PFC (Power Factor Correction) circuit that supplies a sinusoidal output voltage in normal and buffer mode.

UPS characteristics are described and classified in the standards EN 50091-3 or IEC 62040-3. Devices with sinusoidal output voltage in the normal and buffered mode are identified with the classification "VFI-SS-...." or "VI-SS-....".

Note

The power supply of the device contains a PFC (Power Factor Correction) circuit to conform to the EMC directive.

Country-specific information on supply voltage

230 V supply voltage outside of the USA and Canada

This device is equipped with a safety-tested power cord which may only be connected to a grounded shockproof power outlet. If you do not use the power supply cable, use a flexible cable with the following features:

- Conductor cross-section $\geq 0.82 \text{ mm}^2$
- Grounded safety plug 15 A, 250 V

The power supply cable must conform to the safety regulations of the country in which the devices are installed and bear the marks required in each case.

3.3 Connecting the device

230 V supply voltage for the USA and Canada

Use a CSA or UL-listed power supply cable for operation in the United States and Canada. The connector must be compliant with NEMA 5-15.

120 V supply voltage

Use a flexible cable with UL approval and CSA marking as well as the following features:

- Type SJT with three conductors
- Conductor cross-section ≥ 18 AWG
- Cable length ≤ 4.5 m
- Parallel grounding-type plug 15 A, ≥ 125 V

240 V supply voltage

Use a flexible cable with UL approval and CSA marking as well as the following features:

- Type SJT with three conductors
- Conductor cross-section ≥ 18 AWG
- Cable length ≤ 4.5 m
- Tandem grounding-type plug 15 A, ≥ 250 V

Connecting an AC power supply

1. Make sure that the on-off switch ① is in the '0' (off) position.

This prevents unintentional startup of the device when you plug in the power cable.
2. Connect the power cable to socket ②.
3. Insert the power cable in the electrical socket.
4. Switch the on/off switch ① to on (as shown).

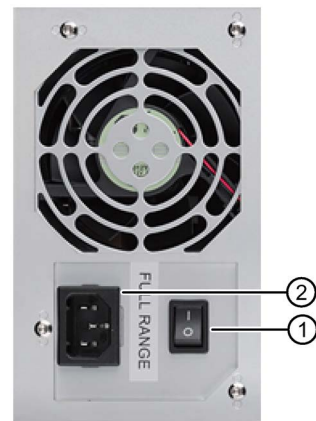

To prevent unintentional removal of the power cable, you can secure the plug as follows:

1. Remove the retaining screw ①.
2. Screw on the latch for the power plug ②.

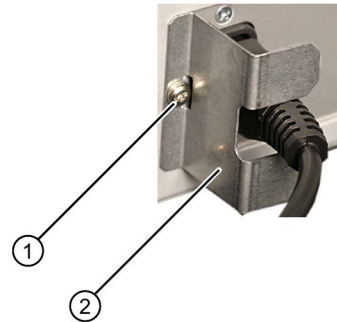

Connecting a redundant power supply

1. Make sure that the on/off switch ② is in the '0' position.
2. Connect a power cable to the two sockets ③.
3. Switch on the two on/off switches ②.

The "Power" LEDs ① on the power supply modules light up green.

Note:

If only one of the power supply modules works, a warning signal sounds. You turn off the warning signal by pressing the ① alarm reset button on the working power supply module.

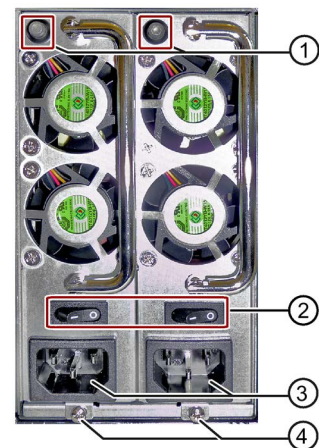

To prevent unintentional removal of the power cable, you can secure the power plug as follows:

1. Remove the retaining screws ④.
2. Screw on the latch for the power plug ⑤ on the thread ④.

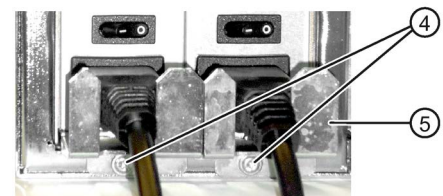

3.3.4 Connecting peripheral equipment

Note

Observe suitability for industrial applications

Only connect I/O devices that are suitable for industrial applications in accordance with EN IEC 61000-6-2.

Note

I/O devices capable of hot-plugging (USB)

Hot-plug I/O devices (USB) may be connected while the PC is in operation.

NOTICE

Non-hot-plug I/O devices

I/O devices that do not support hot-plugging may not be connected until the device is powered off. Strictly adhere to the specifications in the I/O manuals.

Note

Wait at least ten seconds before you reinsert USB devices.

Note that the EMC immunity of standard USB devices is designed only for office environments. These USB devices are appropriate for handling commissioning and service tasks. Only industrial grade USB devices are permitted for use in industrial environments. The USB devices are developed and marketed by the respective supplier. The respective product supplier provides support for the USB devices. The manufacturer's terms of liability shall apply.

Note

A monitor should be connected and switched on before device booting to ensure it is correctly detected and run by the BIOS and the operating system. The screen may otherwise remain dark.

Note

The connected or built-in I/Os should not introduce a counter emf into the device.

A counter e.m.f. greater than 0.5 V to ground on the + 3.3 V DC / + 5 V DC / + 12 V DC due to a connected or integrated component can prevent normal operation or even destroy the computer.

When measuring the counter emf, remember the following:

- The computer in question must be turned off and the power supply connector must be plugged in.
 - During the measurement, all cables from the plant to the computer should be connected.
 - All other components in the plant must be active.
-

3.3.5 Securing the cables

The strain relief provided is used to prevent accidental loosening of the interface cables from the device.

To fix the strain relief, you will need a TORX T10 screwdriver.

Procedure

1. There are two strain reliefs for the interfaces.
2. Screw on the required strain relief on the left and/or right.
3. Insert the detachable cable ties here and fasten the cables with them.
4. Fasten the cables using simple cable ties.

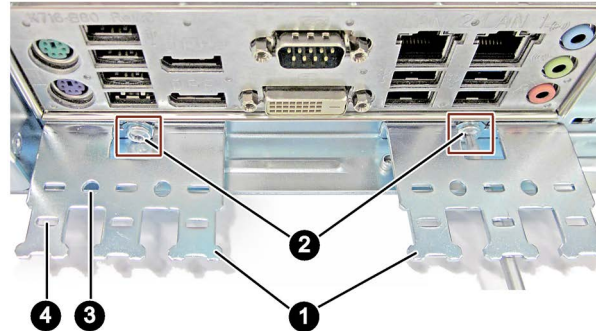

Result

The figure below shows an example of fixing with simple cable ties.



3.3.6 Connecting the device to networks

The following options are available for integrating the device into existing or planned system environments and networks.

Ethernet

Wake on LAN and Remote Boot are supported.

You can use the integrated Ethernet interfaces (10/100/1000 Mbps) for communication and data exchange with automation devices, such as SIMATIC S7.

You need the "SOFTNET S7" software package for this.

PROFINET

PROFINET can be operated via:

- Standard Ethernet interfaces (RT)

SIMATIC NET

Use this software package to create, operate and configure an innovative network for Field & Control level. Information on this can be found on the SIMATIC NET Manual Collection CD. The software package and the documentation are not included in the scope of delivery.

Additional information

You can find additional information on the Internet at:
 Technical Support (<https://support.industry.siemens.com>)

3.3.7 Multi-monitoring

You can operate up to five monitors simultaneously (for a device with motherboard D3445-S: up to four monitors) at the interfaces of the integrated graphics controller in combination with the optional graphics card. Parameter assignment is performed by means of the Control Panel in Windows.

The following monitors can be operated simultaneously on the motherboard:

Device with motherboard D3446-S	Device with motherboard D3445-S
<ul style="list-style-type: none"> • 2 × DisplayPort, 1 × DVI-D • 1 × DisplayPort, 1 × DVI-D via DisplayPort DVI adapter ¹, 1 × DVI-D • 1 × DisplayPort, 1 × VGA via DisplayPort VGA adapter ¹, 1 × DVI-D • 2 × DVI-D via DisplayPort DVI adapter, 1 × DVI-D • 2 × VGA via DisplayPort VGA adapter, 1 × DVI-D • 1 × VGA via DisplayPort VGA adapter, 1 × DVI-D via DisplayPort DVI adapter, 1 × DVI-D <p>¹ available as accessories Detailed information is available in section "Accessories".</p>	<ul style="list-style-type: none"> • 1 × DisplayPort, 1 × DVI-D • 1 × VGA via DisplayPort VGA adapter ¹, 1 × DVI-D • 1 × DVI-D via DisplayPort DVI adapter ¹, 1 × DVI-D <p>¹ available as accessories</p>

Commissioning the device

4.1 General information on commissioning

Requirements for commissioning

The following requirements have to be met before you can start commissioning:

- I/O devices, keyboard, mouse and monitor are connected.
- The power supply is connected.
- An operating system is installed.

The device can be supplied without an operating system. Information on installation of the operating system is available in the section "Installing the software (Page 111)".

4.2 Switching on the device

After the initial switch on, the operating system is set up automatically on the device.

NOTICE
Faulty installation
If you change the default values in the BIOS setup or if you turn off the device during installation, you disrupt the installation and the operating system is not installed correctly. The operating safety of the device and the plant is at risk.
Do not switch off the device during the entire installation process. Do not change the default values in the BIOS setup.

Procedure

1. Switch the on/off switch to position I. Information on the position of the switch is available in the section "Operator controls (Page 19)".
2. Press the on/off button.
The "POWER" LED lights up. The module carries out a self-test. Then Windows is started.
3. Follow the instructions on the screen.

4.3 Automatic switching on of the device

The following steps are required only when switching on the device for the first time after delivery:

4. Make the required region and language settings.

If you want your system language to be international, select English. Information for subsequent changing of the region and language settings, see the section "Setting up the language selection using the Multilanguage User Interface (MUI) (Page 119)".

Note

Once the operating system has been set up, the device may restart.

5. Type in the product key as required.

The product key is located on the "Certificate of Authentication" in the "Product Key" line, see section "Device identification data (Page 32)".

Result

The interface of the operating system is displayed every time you turn on the device and after the startup routine.

4.3 Automatic switching on of the device

You can specify "Power Failure Recovery" in the BIOS Setup entry so that the device automatically starts up again after a separation from the mains voltage for up to two minutes. The time is dependent on the device equipment and the application.

Automatic startup may endanger the operation of the machine or plant, for example, after a power failure.

Take the BIOS Setup entry "Power Failure Recovery" into consideration in the plant planning.

4.4 Notes on various device configurations

4.4.1 DVD burner drive

The DVD burner drive is an optional device feature. Recording methods supported by the disk drive:

- Disc-At-Once
- Track-At-Once
- Session-At-Once
- Packet writing

For additional information, refer to the technical specifications.

Software

In order to use full functionality of the DVD burner you do not need to install additional software under Windows. The software for the DVD burner is part of the mentioned operating systems.

If you are using a different operating system, ensure that the software required for the DVD burner is installed.

Operation

Note

When first starting the burner software, no disks should be inserted in the drive. Faulty data storage media can interrupt the automatic drive recognition. This makes it impossible to correctly display the possible burner functions.

Burner operation is only permitted in an environment free of shock and vibration.

NOTICE
Data errors during burning It cannot be ruled out that vibrations in the environment and varying quality of raw discs could result in data errors when burning data media, even when no error message occurs. Data comparison is the only guarantee that data has been written correctly. Perform data comparison each time you burn a disc.

4.4.2 Hard disks in removable tray

The hard disks in the removable tray can be replaced during operation in connection with RAID (hot swap).

Requirement

- Device with motherboard D3446-S
- A hard disk of the same interface type
- A key for the removable rack unit lock

Always replace the defective hard disk with a new one of the same interface type and capacity.

Procedure

NOTICE
Damage to the hard disk and loss of data
When you remove the hard disk while data is being written to the hard disk, you may damage the hard disk and destroy data.
<ul style="list-style-type: none">• Only remove the removable tray from the device when the hard disk is inactive. Inactive means the hard disk status indicator ② of the removable tray is not flashing (see figure below).• Observe the EGB guidelines.

1. Identify which hard disk the RAID controller has reported as being faulty (see status indicators).
2. Open the front panel.

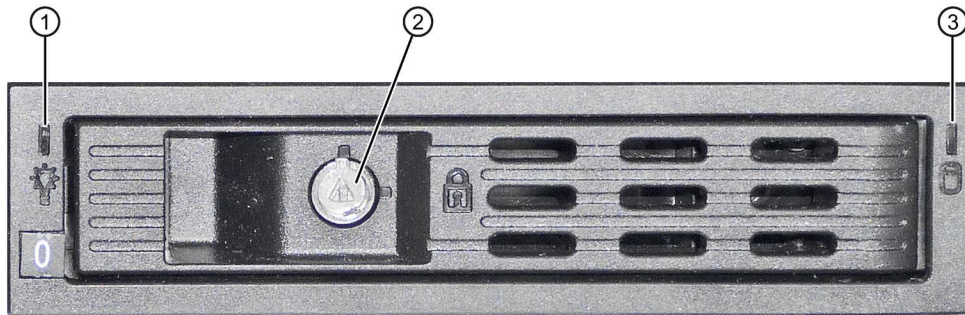

3. Open the lock ② with the appropriate key.
4. Fold out the tray bracket somewhat to the front and pull out the removable tray by the tray bracket.

The procedure is described in the section "Removing and installing the hard disk or SSD in the removable tray (Page 74)".
5. Insert the removable tray with the replaced hard disk into the device and push it all the way in.
6. Fold back the tray bracket until it rests completely against the removable tray.

The power supply LED ① must be on.
7. Close the lock ② with the appropriate key.

Note

Always lock the removable tray to ensure reliable operation of a device with a removable tray.

4.4.3 System with two drives

The system with two drives is an optional feature for the device.

When the device ships, the second drive is connected to SATA port 1. This hard disk drive is not set up. This gives you the option of backing up your data to this hard disk drive. Refer to your order documentation for information on hard disk drive capacity.

Booting from the second hard disk drive

In order to allow booting from the second hard disk drive, you need to configure it as the primary boot device (Boot Option #1). To do this, make the following settings in your BIOS Setup:

1. Select the "Boot" tab.
2. Select the first entry from the list in the "Boot Option Properties": "Boot Option #1" and press the Return key.
3. Select the corresponding drive (slave drive) in the "Boot Option #1" window, e.g. STxxxxxxx, and press the Return key.

The second hard disk drive (slave drive) becomes the primary boot device.

Note

The drive letters for the partitions on both drives are assigned by the operating system in use. You can change these in the Control Panel as required.

4.4.4 RAID systems

4.4.4.1 Manage RAID system

RAID system management functions

The RAID system is fully set up ex works. The installed SIMATIC diagnostic software is used to display the status of the RAID system. Additional software is not required. Detailed information on drive replacement is available in section "Expansion and parameter assignment of device", "Replace defective hard disk in RAID system".

Note

A hard disk can be synchronized at operating system level if a fault is detected. It may take a very long time to synchronize a new hard disk in the background, depending on the size of the hard disk and on the system load. It may take several hours or even days in the case of extremely high hard disk load. Guide value for duration < 3 h with 90% HDD system load and RAID5 with HDD 1 TB.

The safe system states RAID Level, for example, 1 are only reached once synchronization has been successfully completed. In addition, system performance may be limited in the case of a manually started maintenance operation until completion of the maintenance phase.

Replacing a faulty drive in the RAID system

Replace the faulty drive with a new drive of the same type and capacity to return to the safe RAID1 or RAID5 state after a fault. The defective drive is displayed at the HDD alarm LED at the front of the device.

The diagnostic software indicates the following:

- A defective drive
- Details of the functioning hard disk

The defective hard disk is displayed with port number. You can find detailed information on drive replacement in the following sections:

- "Hard disks in removable tray (Page 47)"
- "Replacing a defective hard disk drive in the RAID system (Page 81)"

Integrating a new hard disk

A hard disk is integrated automatically into the RAID if it fulfills one of the following requirements:

- The hard disk is brand new.
- The hard disk is set up as a global spare drive.
- The hard disk is set up as a specific (dedicated spare) drive.

4.4.4.2 RAID1 system

This is a RAID1 system configuration (data mirroring with two drives). This means that if there is a defective hard disk or there are cable problems, the system can continue to operate in one channel and achieve a high degree of availability.

Note

You will find information about the RAID controller in the "Drivers\RAID-AHCI\Intel" directory on the "Documentation and Drivers" DVD that ships with the product.

Additional information on RAID1 systems can be found in the section "Manage onboard RAID system (Page 92)".

4.4.4.3 RAID5 system

This is a RAID5 system configuration (striping with parity). This means that if there is a defective hard disk or there are cable problems, the system can continue to operate in one channel and achieve a high degree of availability.

Note

You will find information about the RAID controller in the "Drivers\RAID-AHCI\Intel" directory on the "Documentation and Drivers" DVD that ships with the product.

Additional information on RAID5 systems can be found in the section "Manage onboard RAID system (Page 92)".

4.4.4.4 RAID system with hot spare drive

In the factory state, the device is configured as a RAID1 or RAID5 system with a hot spare drive. A hot spare drive is a drive included in the device as spare.

If a defective drive is detected in the RAID1 or RAID5 system, the hot spare drive is automatically integrated during ongoing operation instead of the defective drive and takes over its function. The rebuild process to the hot spare drive starts automatically.

The defective drive is signaled as status display by the SIMATIC IPC DiagBase Alarm Manager.

A data-secure system is restored once synchronization is complete.

To restore full functionality of the RAID system with hot spare drive, you must replace the defective drive with a new one and integrate it once again as hot spare drive in the RAID system in the RAID software.

- Information on replacing the hot spare drive is available in the section "Replacing a defective hard disk drive in the RAID system (Page 81)".
- Information on integration of a replaced hot spare drive into the RAID system is available in the section "Integrating a hot spare hard disk drive in the RAID system (Page 98)".

4.5 Windows Action Center

The Action Center checks the status of the device with regard to the important safety aspects listed below. If a problem is found, the Action Center provides recommendations on how you can better protect the device.

Functions

- **Firewall:** The Windows Firewall adds protection to the device by blocking network or Internet access to the device by unauthorized users. The firewall is enabled in the delivery state.
- **Antivirus software:** Antivirus programs add protection to the device by searching for and eliminating viruses and other security threats. No antivirus software is installed in the delivery state.
- **Automatic updates:** Using the Automatic Update feature allows Windows to regularly search for the latest critical updates for the device and to install them automatically.

This option is disabled in the delivery state for Windows Server 2008 R2 and Windows Server 2012 R2. You can enable or disable this option for Windows 7 and Windows 10 during commissioning of Windows.

- **User Account Control:** User Account Control issues a warning when programs attempt to modify important Windows settings. You can then either acknowledge this warning or prevent the program from changing the Windows settings.

This option is disabled in the delivery state for Windows Server 2008 R2 and Windows Server 2012 R2. This option is enabled in the delivery state for Windows 7 and Windows 10.

4.6 Switching off the device

Shutting down the operating system

For Windows operating systems:

1. Click on a free area of the Windows Desktop with the left mouse button.
Alternatively, press the key combination <Win+D>.
 2. Press the key combination <Alt+F4>.
 3. Select "Shutdown".
- As an alternative to steps 1-3, briefly press the on/off button (unless otherwise configured in the power options). Information on the position of the button is available in the section "Operator controls (Page 19)".

For non-Windows operating systems:

- Briefly press the on/off button.

The operating system is shut down. The "POWER" LED will light up yellow. The device is switched off but not fully disconnected from the mains voltage.

Fully disconnecting the device from mains voltage

 WARNING
Risk of fire and electric shock
The on/off button and on/off switch do not fully disconnect the device from the mains. If the device is switched off with the on/off switch, there remains a risk of electric shock and fire hazard, for example, if the device or connection cables are damaged or if the device is used improperly.
Always fully disconnect the device from the mains voltage as described below before performing work on the device or when the device will not be used over an extended period of time.

If the device was not mounted in a control cabinet:

- Shut down the operating system and pull the power plug on the rear of the device.

If the device was mounted in a control cabinet:

- Shut down the operating system and switch the on/off switch to "Off".

The device is switched off and fully disconnected from the mains voltage. No trickle current is flowing.

Hardware reset

You can perform a hardware reset to restart the device when the operating system no longer responds to input from the keyboard or mouse. The operating system is not safely shut down in this case.

NOTICE
Risk of data loss
The device is restarted in the case of a hardware reset. Data in the main memory can be deleted. Data on the drive may be lost. The device may be damaged.
Perform a hardware reset only in the case of an emergency.

Procedure:

1. Press the on/off button for more than 4 seconds.
2. Alternatively, you can press the reset button.

Expanded device functions

5.1 Monitoring functions

SIMATIC IPC DiagBase software

Even in its basic version, the device supports the use of monitoring functions. The SIMATIC IPC DiagBase software, which is included in the scope of delivery, provides the following local display, monitoring and control functions:

- Temperature monitoring (over-temperature, under-temperature or cable break at a temperature sensor)
- Fan monitoring (fan speed too low, fan failure, or a break in a tachometer line)
- Monitoring of drives (HDD and SSD) with S.M.A.R.T functionality even in a RAID system
- Watchdog (hardware or software reset ¹ of the computer)
- Operating hours meter (information on the cumulative run time)
- Battery monitoring. The charge level of the CMOS battery is monitored.

¹ Not available with all devices.

Use the "Management Explorer" application for clear control. Use the "Alarm Manager" to receive notifications about individual alarms.

Note

Additional information on the functionality of the SIMATIC IPC DiagBase software is available in the online help.

SIMATIC IPC DiagMonitor software

The SIMATIC IPC DiagMonitor software is available on DVD and can be ordered as an option with the configurator. The software is included with the device when you order it. The SIMATIC IPC DiagMonitor software offers additional alarm and linking options in addition to the local monitoring functions of the SIMATIC IPC DiagBase software and includes:

- The software for the stations to be monitored.
- A library for creating user-specific applications.

Note

SIMATIC IPC DiagMonitor only supports the device hardware as of version 4.5.2.

Older versions do not support the device hardware.

5.1.1 Temperature monitoring and temperature display

The temperature is detected at critical device locations by temperature sensors. A temperature sensor monitors the processor temperature. Other temperature sensors monitor further critical points.

If the set temperature threshold is exceeded at a temperature sensor, the following reactions are triggered:

- The "TEMP" status display flashes red. The temperature sensor of the dual-head graphics cards has no influence on this.
- The device fans are running at full speed.
- The fans of the power supply and the optional graphics card are controlled via these components.
- A temperature alarm is output if the SIMATIC monitoring software is installed.

Note

When the device is operated according to instructions, no temperature error occurs.

In the event of a temperature error, check the following possible causes:

- Ventilation openings are covered
- Filter is heavily polluted
- Fan has failed
- Ambient temperature is above the permitted value
- Output power of the power supply is exceeded

The temperature error remains stored until the monitored temperatures fall below the temperature threshold that is set. You can reset the error message with one of the following measures:

- Acknowledge error message with SIMATIC IPC DiagBase or SIMATIC IPC DiagMonitor
- Short-term disconnection of the device from the power supply
- Shut down device
- Restart the device

5.1.2 Fan monitoring

The operation of front fans, CPU, dual-head graphic card fans, power supply fans and fans on the drive cage type A are monitored by SIMATIC monitoring software.

If a fan fails, the following reactions are triggered:

- The status indicator "FAN" flashes red. The fan of the dual-head graphics cards has no influence on this.
- If the SIMATIC monitoring software is active, a fan alarm is output.

The fan error remains stored until the cause has been rectified. You can reset the error message with one of the following measures:

- Acknowledge error message with SIMATIC IPC DiagBase or SIMATIC IPC DiagMonitor
- Short-term disconnection of the device from the power supply
- Shut down device
- Restart the device

5.1.3 Watchdog (WD)

Configuration

You configure the watchdog with the DiagBase or DiagMonitor software.

Function

The watchdog is able to monitor system runtime and informs the user about the different reactions that are triggered if the system does not respond to the watchdog within the specified monitoring time.

A watchdog alarm is retained after a restart and is reset and logged by the DiagBase or DiagMonitor software. The watchdog configuration is retained in the process.

Watchdog reactions

The following reactions can occur if the watchdog is not addressed within the set time:

Option	Reaction
Reset on	Executes a hardware reset when the watchdog expires
Reset off ¹	Executes no action when the watchdog expires
Restart ¹	Restarts the operating system when the watchdog expires
Shutdown ¹	Shuts down the operating system when the watchdog expires

¹ Option is device-specific.

NOTICE
<p>"Reset on" option</p> <p>The "Reset on" option immediately triggers a hardware reset that may result in loss of data under Windows and damage to the installation.</p>

Watchdog monitoring times

The monitoring time can be configured with the DiagBase or DiagMonitor software.

Note

When you change the monitoring time, the change becomes effective immediately.

5.1.4 Battery monitoring

The installed backup battery for backup of CMOS data has a limited life span. Information on the shelf life is available in the section "Replacing the backup battery (Page 102)".

A two-tier battery monitoring checks the status of the backup battery. The SIMATIC IPC DiagBase and SIMATIC IPC DiagMonitor diagnostic software determines the status of the backup battery.

When the first warning threshold is reached, the backup battery will run for at least one more month.

5.1.5 Drive monitoring

The SIMATIC IPC DiagBase software and SIMATIC IPC DiagMonitor software determine the status of the drives.

- SMART messages of the hard drives are signaled.
- The following states are displayed in a RAID system:
 - "Normal", "OK" in SIMATIC IPC DiagBase
 - "Degraded", error in SIMATIC IPC DiagBase
 - "Rebuild", rebuilding in SIMATIC IPC DiagBase.

The status of an inactive hot swap drive is not displayed.

5.2 Active Management Technology (AMT)

Active Management Technology (AMT) is technology for the remote maintenance of computers, simply called AMT-PC in the remainder of the document, which includes the following functions:

- **Keyboard-Video-Mouse-Redirection**
Using KVM that is integrated in the AMT hardware you access the AMT PC remotely. With KVM Redirection, you can also control AMT PCs that have no operating system or a defective operating system. A KVM remote session is always possible with the KVM server integrated in the firmware. This means you can restart the PC and change the BIOS setup remotely.
- **Remote power management**
AMT PCs can be turned on and off and restarted from another PC.
- **Serial over LAN**
Redirection of the data of a serial interface to the network. The main use of the function is text-based remote control of an AMT PC using a console.
- **IDE redirection**
An ISO file on the help desk PC can be mounted on the AMT PC and used as a DVD drive. An ISO file contains a memory image of the content of a CD or DVD structured in the ISO 9660 format.
- **Remote reboot**
An AMT PC can be booted remotely from a bootable ISO file made available by another PC.

SIMATIC IPC Remote Manager

The "SIMATIC IPC Remote Manager" software is available for utilization of the AMT functions with SIMATIC IPCs. The software can be ordered from the Siemens online ordering system. For detailed information about "SIMATIC IPC Remote Manager", refer to the corresponding product documentation: SIMATIC IPC Remote Manager (<http://support.automation.siemens.com/WW/view/en/48707158>)

Typical areas of application and functions of the SIMATIC IPC Remote Manager:

- Remote maintenance of SIMATIC IPC with AMT, for example, for service purposes in the case of a defective operating system or for adapting BIOS settings
- Diagnostics without on-site use
- Convenient service by access to AMT clients, such as headless systems, without additional hardware
- Resource management

Requirement

- A device with an Intel® Core™ i5 processor or Intel Core™ i7- or Xeon processor
- Device with motherboard D3446-S
- A functioning and configured "Management Engine"
- A functioning and configured Ethernet connection
- A help desk PC with a functioning and configured Ethernet connection for the full AMT functionality

Configuring AMT-PC

You configure AMT by means of the BIOS setup and MEBx. MEBx is a BIOS extension for configuring AMT.

5.3 Trusted Platform Module (TPM)

Depending on the ordered configuration of your device, a Trusted Platform Module according to Standard TPM V2.0 may be available. The Trusted Platform Module is a chip that enhances your device with security functions. It provides an improved protection from manipulation of the PC. The Trusted Platform Module can be activated in the "Advanced > Trusted Computing" menu of the BIOS Setup. Please note the respective import and export provisions for the Trusted Platform Module.

Using the Trusted Platform Module

The TPM can be used with the "BitLocker" drive encrypter, for example, in Windows operating systems. Please follow the instructions for this in the operating system.

Note

Risk of data loss

If you lose the password for the drive encryption, you will not be able to restore the data. You will then lose access to the encrypted drive.

The warranty does not cover a reset of the hardware in the event of a loss of a password.

Please store the password carefully and make sure it is protected against unauthorized access.

Use of the Trusted Platform module TPM 2.0 under Windows 7, Windows Server 2008 R2 and 2012 R2

If you install the operating system yourself, the following requirements must be met:

- The operating system is installed and booted with the setting "UEFI Boot Type", see BIOS setup, section "Boot menu".

During installation the drive is set up as a GBT partition.

- Hotfix KB2920188 has been installed More information can be found on the Microsoft homepage "Support for TPM 2.0 (<https://support.microsoft.com/en-us/kb/2920188>)".

Expanding and assigning parameters to the device

6.1 Information on expansions

The permissible expansion of the device is described below, as well as the resulting permissible operating conditions.

Installation of expansions

WARNING

Unauthorized opening and improper repairs or expansions on the device may result in substantial damage to equipment or endanger the user.

- Always disconnect the power plug before you open the device.
- Only install system expansion devices designed for this device. If you install other expansion devices, you may damage the device or violate the safety requirements and regulations on RF suppression. Contact your technical support team or where you purchased your PC to find out which system expansion devices may be installed.

If you install or exchange system expansions and damage your device, the warranty becomes void.

CAUTION

Electrostatic sensitive devices (ESD)

The device contains electronic components which are destroyed by electrostatic charges. This can result in malfunctions and damage to the machine or plant.

Make sure you take precautionary measures even when you open the device, for example, when opening device doors, device covers or the enclosure cover. For more information, please refer to the chapter "ESD directives".

Limitation of liability

All technical specifications and approvals of the device only apply if you use expansion components that have a valid CE approval (CE mark). The installation instructions for expansion components in the associated documentation must be observed.

UL approval of the device only applies when the UL-approved components are used according to their "Conditions of Acceptability".

We are not liable for functional limitations caused by the use of third-party devices or components.

Tools

You can make repairs on the device with the following tools:

- T20 screwdriver for protective conductor connection and enclosure
- T6 screwdriver for removing and installing the DVD drive
- T10 screwdriver for all of the remaining screws

See also

ESD guideline (Page 127)

Spare parts and repairs (<http://support.automation.siemens.com/WW/view/en/16611927>)

6.1.1 Drives in the standard enclosure

Drives can be installed in the standard enclosure as follows:

- In the drive cage type A for operable drives in the removable tray
- In the cage for internal mounting of drive
- On a drive bay plate on the left-hand side wall

6.1.1.1 Permissible expansion for temperature range 0 to 35 °C

Enclosure variant with drive cage type A

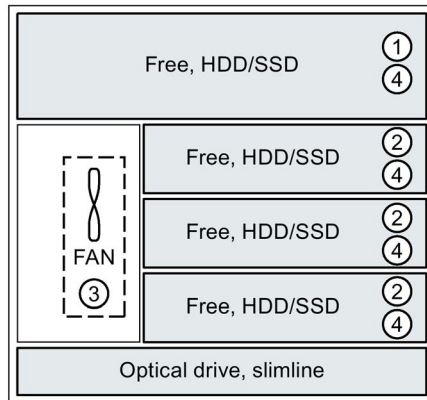

- ① Drive in 5.25" adapter for removable tray
- ② Drive in removable tray
- ③ Fan on drive cage type A. The fan is only required in conjunction with the hard disk type "Enterprise"
- ④ Hard disk type "Enterprise" is possible

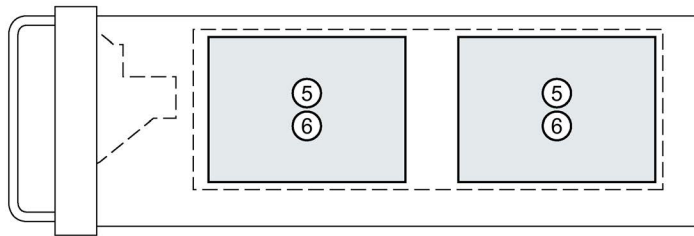

- ⑤ Additional drive mounted on the left-hand side wall on the drive bay plate For details, see section "Installing and replacing the internal hard disk or SSD on the side wall (Page 79)."
- ⑥ Hard disk type "Enterprise" is possible

The maximum permitted power loss of the expansion cards is 80 W.

If the device is permanently installed or mounted on telescopic rails, it must not be subjected to vibration stress during operation. The restrictions do not apply for the use of SSD.

Motherboard	Number of drives	AHCI	RAID 1	RAID 5	Spare drive
D3445	4	X	-	-	-
D3446	6	X	X	X	RAID 1 / 5

Enclosure variant with drive cage type B

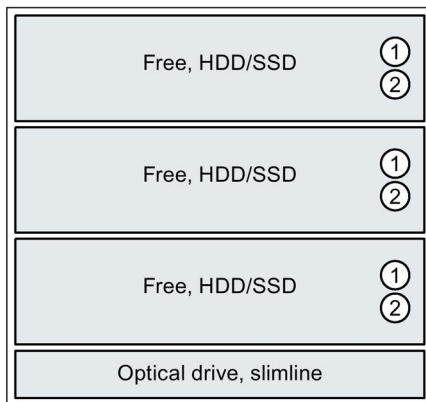

- ① Drive in drive bay for internal robust installation
- ② Hard disk type "Enterprise" is possible

The maximum permitted power loss of the expansion cards is 80 W.

If the device is permanently installed or mounted on telescopic rails, it may be subjected to the following vibration stress during operation:

- 20 to 58 Hz: 0.015 mm
- 58 Hz to 200 Hz: 2 m/s²

Vibrations may not exceed 200 Hz.

Motherboard	Number of drives	AHCI	RAID 1	RAID 5	Spare drive
D3445	4	X	-	-	-
D3446	4	X	X	X	RAID 1

6.1.1.2 Permissible expansion for temperature range 0 to 40 °C

Enclosure variant with drive cage type A

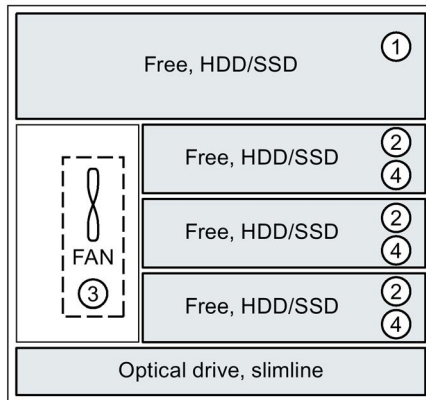

- ① Drive in 5.25" adapter for removable tray
- ② Drive in removable tray
- ③ Fan on drive cage type A. The fan is only required in conjunction with the hard disk type "Enterprise"
- ④ Hard disk type "Enterprise" is possible (max. 3 drives)

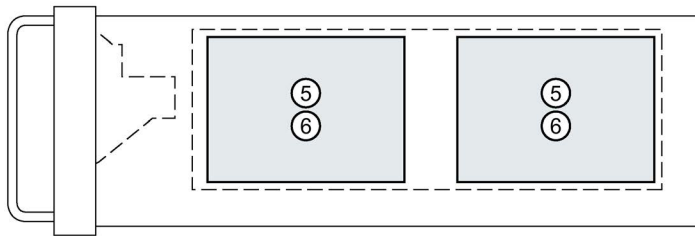

- ⑤ Additional drive mounted on the left-hand side wall on the drive bay plate For details, see section "Installing and replacing the internal hard disk or SSD on the side wall (Page 79)."
- ⑥ Hard disk type "Enterprise" is possible

The maximum permitted power loss of the expansion cards is 80 W.

If the device is permanently installed or mounted on telescopic rails, it must not be subjected to vibration stress during operation. The restrictions do not apply for the use of SSD.

Motherboard	Number of drives	AHCI	RAID 1	RAID 5	Spare drive
D3445	4	X	-	-	-
D3446	6	X	X	X *	RAID 1 / 5 *

* Not approved with "Enterprise" hard disk type

Enclosure variant with drive cage type B

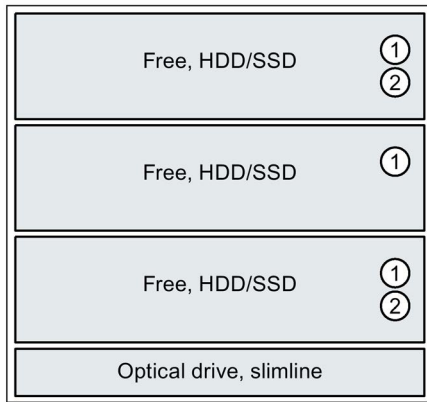

- ① Drive in drive bay for internal robust installation
- ② Hard disk type "Enterprise" is possible

The maximum permitted power loss of the expansion cards is 80 W.

If the device is permanently installed or mounted on telescopic rails, it may be subjected to the following vibration stress during operation:

- 20 to 58 Hz: 0.015 mm
- 58 Hz to 200 Hz: 2 m/s²

Vibrations may not exceed 200 Hz.

Motherboard	Number of drives	AHCI	RAID 1	RAID 5	Spare drive
D3445	4	X	-	-	-
D3446	4	X	X	X *	RAID 1 *

* Not in connection with "Enterprise" hard disk type

6.2 Opening the front door

Procedure

1. Open the front door with the key.
2. Pull the front door to the side.



6.3 Open the device

NOTICE

Malfunctions and electric shock

Improper intervention in the device endangers operational reliability and may damage the device.

The results are personal injuries and damage to the plant.

Take the following precautions:

- Always disconnect the power plug before you open the device.
- Close the device after every intervention.

⚠ CAUTION

Electrostatic sensitive devices (ESD)

The device contains electronic components which are destroyed by electrostatic charges. This can result in malfunctions and damage to the machine or plant.

Take the appropriate precautions.

Requirement

- The front door is open; see "Opening the front door (Page 67)".
- The device is fully disconnected from the mains voltage; see section "Switching off the device (Page 53)".
- All connection cables are unplugged.
- T10 screwdriver

Procedure

1. Remove the captive screw.
2. Push the enclosure cover back.
3. Lift up and remove the enclosure cover.

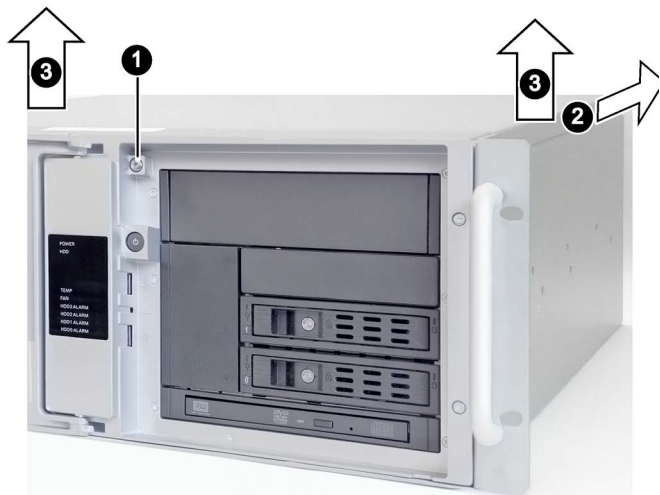

6.4 Memory expansion

Depending on the device version there are two or four slots for memory modules on the motherboard. You can expand the memory up to 64 GB, for devices with motherboard D3445-S up to 32 GB. Of which 3.2 GB can be used in a 32-bit operating system.

The following memory modules can be installed:

Motherboard	Number of slots	2 GB *	4 GB	8 GB *	16 GB *	Max. possible
D3445	2	-	X	X	X	32 GB
D3446	4	-	X	X	X	64 GB

* The following memory module types are approved: DDR4 SDRAM PC4-2400T/s

A detailed description of possible memory expansion options is available in the manual of the motherboard on the supplied "Documentation and Drivers" DVD.

6.5 Installing expansion cards

Note the following:

- Specification of the expansion cards

The device is designed for the following types of expansion cards:

- PCI specification 2.3
- PCIe Gen 2, expansion cards of the PCIe type Gen 1 and Gen 2 are supported.
- PCIe Gen 2, expansion cards of the PCIe type Gen 1, Gen 2, Gen 3 and PEG are supported.

PCI expansion cards with 5 V and 3.3 V supply voltage can be operated.

The expansion cards must not exceed the specified dimensions. If the height is exceeded, you may experience contact problems, malfunctions and difficulties with the assembly.

You can find the permitted dimensions for expansion cards in the chapter "Dimension drawing of the expansion cards (Page 130)".

Note

Output is limited for PCI expansion cards with 5 V supply voltage. The total power consumption of the expansion cards must be ≤ 25 W.

-
- Long PCI/PCIe expansion cards: To insert such expansion cards into the guide rails, they must be equipped with an extender.

Note

Long expansion cards are only supported in a device with a standard enclosure.

Requirement

- The device is fully disconnected from the mains voltage; see section "Switching off the device (Page 53)".
- The device is open; see section "Open the device (Page 67)".

Note

The accessory pack of the device includes three long card retainers for expansion cards with low overall height. Use these instead of the card retainers installed in the device.

Procedure

1. Hold the bar ① with the card retainer on both ends and remove it by pulling it upwards.

The bar is latched on both ends.

2. Remove the slot bracket ② for the required slot.
3. Insert the expansion card into the free slot ③ on the motherboard.
4. Secure the expansion card with the screw ④.
5. Insert the bar ① with the card retainers.
6. Detach the card retainer in question and place it on the expansion card in the slot ③.
7. Secure the card retainer with the locking screw ⑤.

If you are installing a short expansion card, remove the locking screw ⑤ from the card retainer and install it in the opposite hole.

If you install a low-profile expansion card, use the longer card retainer (included in the product package) for fixing.

8. Close the device.

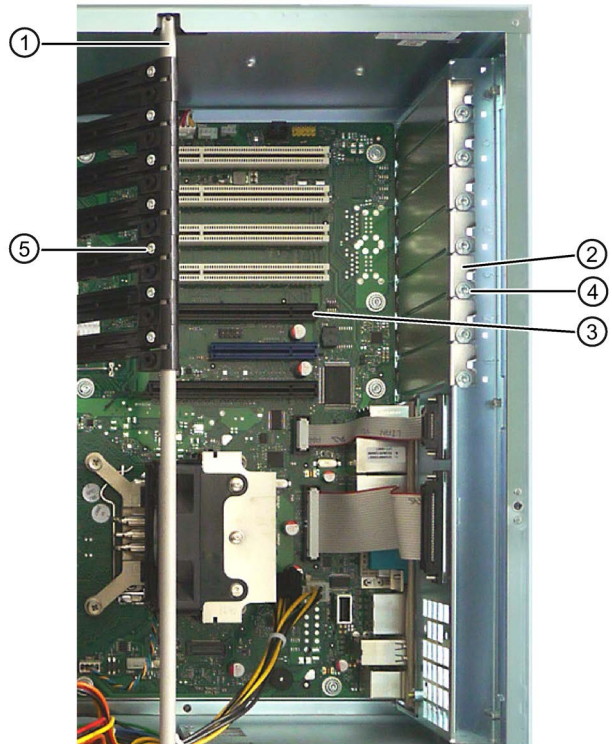

6.6 Drives

6.6.1 Overview of drives

The device has two different drive cages, type A with removable trays and type B; see section "Features (Page 11)".

Note

You can remove the drive bays from the drive cage without any tools.

6.6.2 Removing and installing a 3.5"/2.5" drive in drive cage type B

Requirement

- The device is equipped with the drive cage type B.
- The device is fully disconnected from the mains voltage; see section "Switching off the device (Page 53)".
- The device is open; see section "Open the device (Page 67)".
- Screwdriver T10 for loosening the HDD
- Screwdriver T8 for loosening the SSD



① Drive with drive bay cover

Procedure

1. Remove the power supply and data cables from the drive.
2. Unlock the drive mounting bar by pressing laterally against the surfaces ① and push the drive mounting bar forward from the device in the direction of the arrow ②. Carefully set down the drive mounting bar.

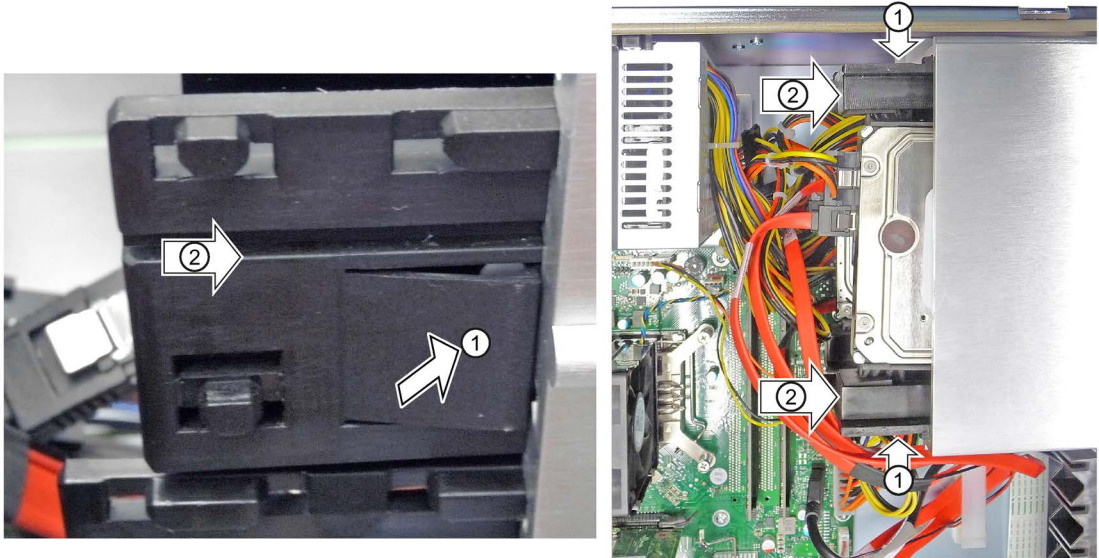

3. As shown below, remove the left and right drive mounting bars ② laterally and the drive bay cover ③ from the front.

Note: The mounting bars are labeled with "L" and "R" and must be remounted in the same way on the "left" and "right" (see corresponding marking on drive bay cover ③).

The figures in this and the next step show a HDD on the left and an SSD on the right.



- Loosen the four screws ④ and remove the drive from the drive bay.

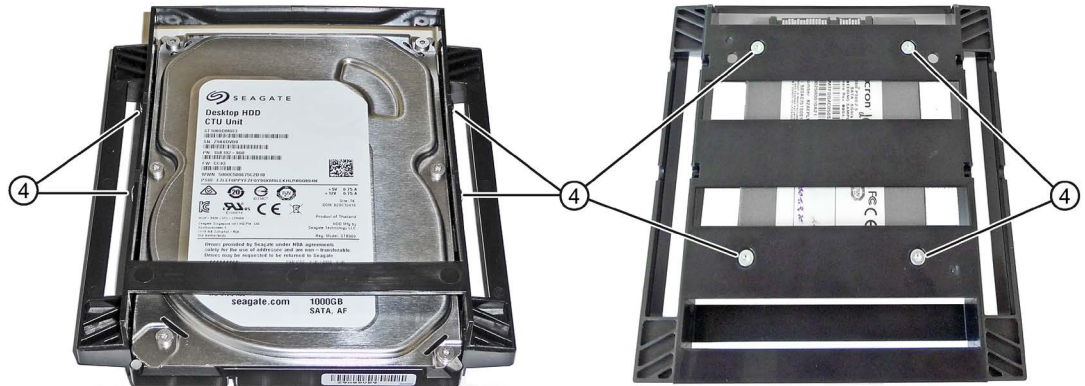

- Place the new drive on the drive bay. The new drive must point upwards as shown in the figure.
- Fasten the new drive with screws ④. Start at the hole marked with "1" on the drive bay.
- Attach the left and right drive mounting bars ② as shown.



- Push the drive bay in the guide rail ① on the left and right 3/4 into the drive cage evenly without tilting.

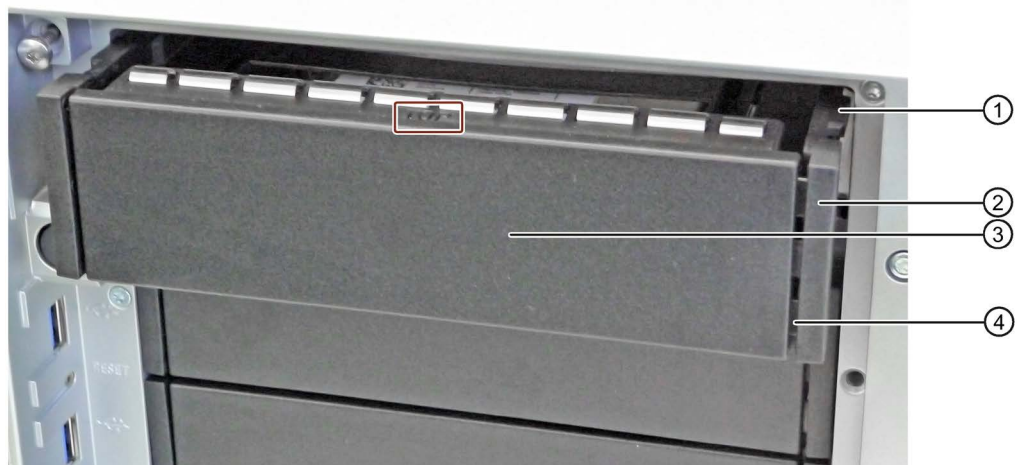

- Insert the drive bay cover ③ between the drive mounting bars ②. The pins ④ must lock into the openings ② on the left and right.

10. Push the drive bay in fully and evenly on the left and the right until you hear it click into the drive cage.
11. Connect the power and data cables to the drive.

6.6.3 Removing and installing the hard disk or SSD in the removable tray

Requirement

- The device is equipped with the drive cage type A.
- If there is no RAID: The device is fully disconnected from the mains voltage, see section "Switching off the device (Page 53)".
- The front door is open; see section "Opening the front door (Page 67)".
- Screwdriver T10 for loosening the HDD
- Screwdriver T8 for loosening the SSD

Procedure

Removal

1. Open the lock of the removable tray with the appropriate key.



2. Open the tray bracket on the removable tray and open it at the highlighted spot in the direction of the arrow until you feel a slight resistance.

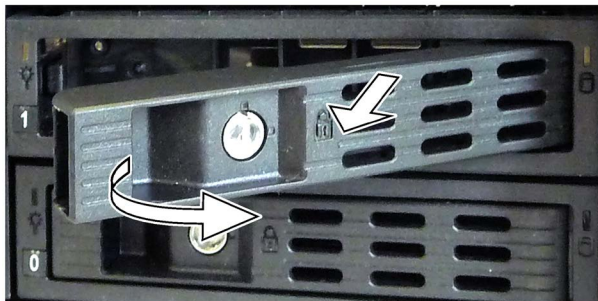

3. Now grip the tray bracket to the right of the notch, pull the removable tray all the way out of the device and put it down.
4. Loosen the highlighted screws on the bottom of the removable tray and remove the drive.

The figure on the left shows an HDD as the drive and the figure on the right shows an SSD.

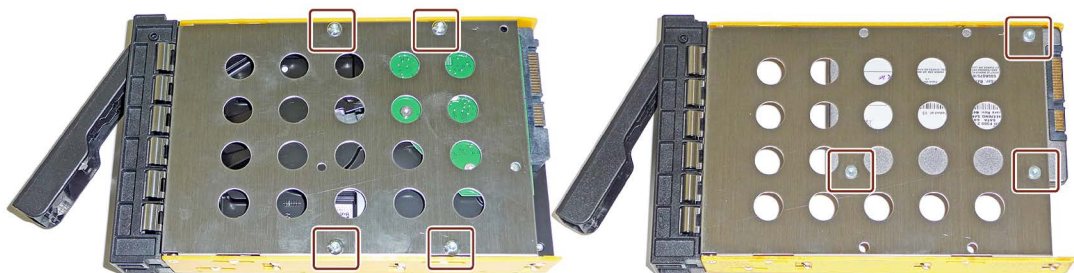

Installation

1. Carefully insert the new drive into the removable tray.
Take care not to touch the contacts of the drive when you do this.
2. Fasten the new drive with the screws to the base of the removable tray.
Only use the original screws.
3. Carefully insert the removable tray into the drive cage of the device again.
4. Fold the tray bracket out of the removable tray as far as it will go and slide the removable tray fully into the drive cage.
Ensure that the removable tray fits tightly in the drive cage.
5. Close the tray bracket.
6. Lock the removable tray with the key.

Note

The removable tray must always be locked to ensure reliable operation of the devices with removable trays.

6.6.4 Hard disk or SSD, device with drive cage type A**Requirement**

- The device is equipped with the drive cage type A.
- The device is fully disconnected from the mains voltage, see section "Switching off the device (Page 53)".
- The device is open; see section "Open the device (Page 67)".
- Screwdriver T10 for loosening the HDD
- Screwdriver T8 for loosening the SSD

See also

Opening the front door (Page 67)

6.6.4.1 Installing a hard disk drive or SSD in slot 0 to 2

Procedure

1. Press the locks ① of the cover ③ together inside the device and keep them pressed.
2. Push the locks to the front in the direction of the arrow ②.
3. Remove the cover ③ upwards at an angle at the front of the device.



4. Remove the now freely accessible slot cover ④. If required, remove other slot covers or removable trays until the drive cage is freely accessible.

5. Insert the new adapter module for the removable tray ⑤ into the drive bay ⑥ from the front and snap it into place at the back.

Check the following:

- The adapter module ⑤ is straight in the drive cage and flat at the back as highlighted.
- All centering openings ⑧ of the adapter module lie in the centering pins ⑦.
- The adapter module is clipped in behind the latches ⑨ as highlighted.
- All adapter modules lie exactly underneath each other, vertically aligned, when viewed from above.

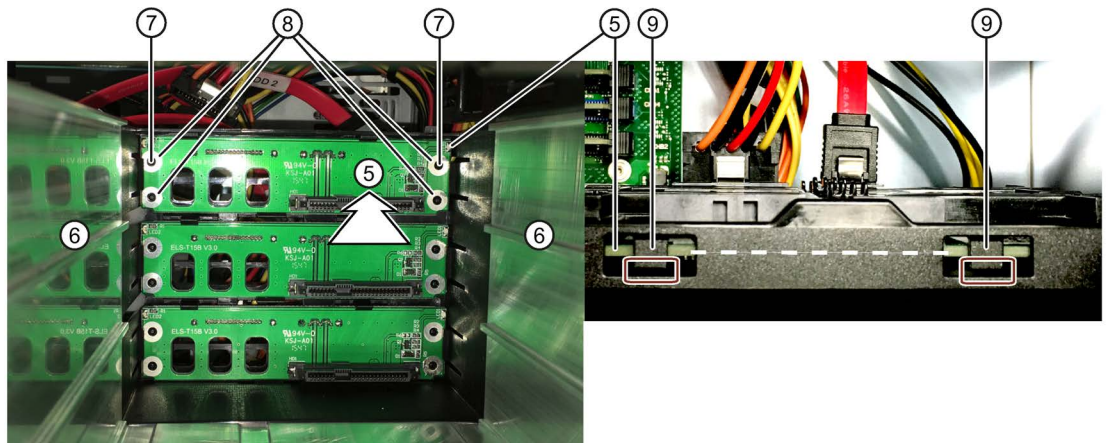

6. Mount the required slot covers or removable trays again from step 4.
7. Insert the cover ③ into the front of the device.
8. Connect the SATA cables to the required SATA connectors of the motherboard and to the new adapter module ⑤.
9. Connect the power supply.
10. Install the corresponding removable tray with mounted hard drive or SSD and lock it (see previous section).
11. Close the device.

6.6.4.2 Installing a hard disk or SSD in slot 3



① Drive bay cover

Procedure

1. Unlock the slot cover by pressing laterally against the surfaces ① and pushing the mounting bar forwards from the device in the direction of the arrow ②. Carefully set down the mounting bars.

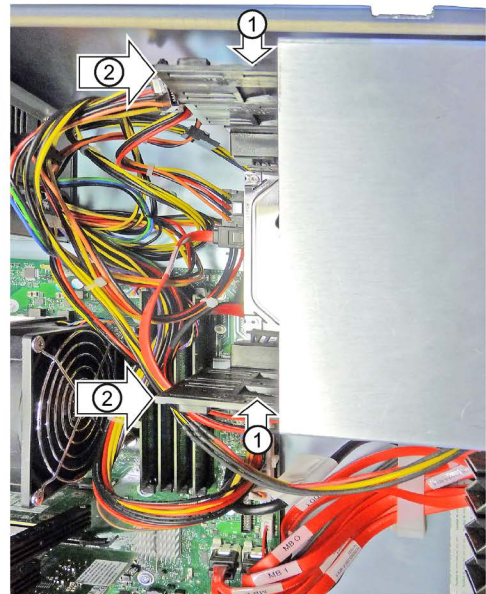
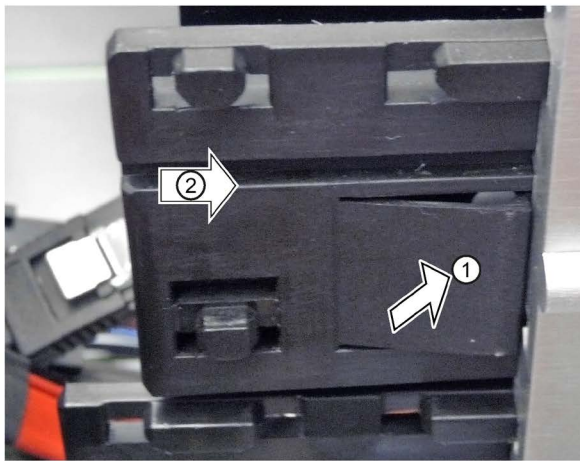

2. Push the 5.25" adapter for the removable rack unit shown below from the front into the drive cage.



3. Connect the SATA cables to the required SATA connectors of the motherboard and to the adapter module of the new 5.25" adapter.
4. Connect the power supply.
5. Install the removable tray with installed drive and lock it; see section "Removing and installing the hard disk or SSD in the removable tray (Page 74)".
6. Close the device.

6.6.4.3 Installing and replacing the internal hard disk or SSD on the side wall

Note

By installing the drives on the side wall, expansion slot 7 can no longer be used.

Procedure

Installing a drive

1. Screw the drive to the drive bay plate (available as option, not included in product package) at the marked holes.



2. Screw from outside the drive bay plate on the inside to the side wall of the enclosure, at position ① or position ②. The SATA connections each lie in the middle ③.

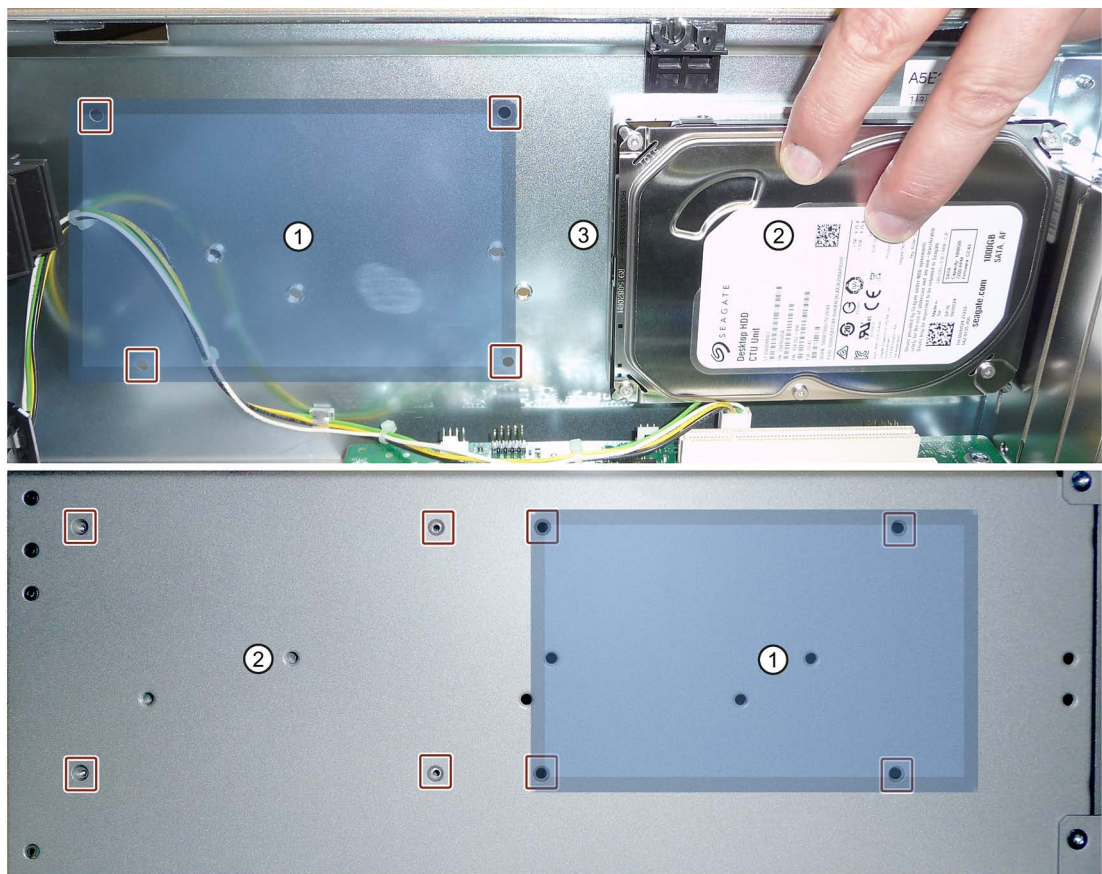

3. Connect the SATA cables to the required SATA connectors of the motherboard and to the drive (position ③).
4. Connect the power supply.
5. Close the device.

Replacing the drive

1. To remove the drive, following the described procedure in the reverse order.
2. Reverse the procedure to install the drive.

6.6.5 Replacing a defective hard disk drive in the RAID system

Hard disks can be replaced during operation in the removable tray in connection with a configured RAID1 system or RAID5 system. This functionality is referred to as "Hot Swap".

Note

If you have configured a non-RAID system with several hard disk drives, you need to turn off the device before you replace a hard disk drive.

 CAUTION
--

Damaging the drive

If you replace a drive while it is active, the drive and data are corrupted. The device can no longer be operated without problems.

Replace the drive in the removable tray only when the "HDD" status display of the device is not lit.
--

Observe the EGB guidelines. Always replace the drive with a new drive of the same type and capacity.

Mounting locations for hard disk drives in the RAID1 system

Hard disk drives for a RAID1 system are internally permanently built into the device (see previous section) or in the removable tray (described in this section).

Note

Replacement of a hard disk drive in the removable tray and in the RAID system can be performed without switching off the device. An internal hard disk drive may only be replaced when the device is switched off.

The new hard disk drive can be integrated into the RAID1 system at operating system level with the RAID software. Synchronization may take several hours, depending on system load.



Similar to figure

- ① Removable tray 1
- ② Removable tray 0
- ③ "Power" LED; power supply available
- ④ "HDD" LED, access to hard disk drive

Status displays of the hard disk drives in a RAID1 system

A defective hard disk drive in the RAID system is signaled with the status displays at the front of the device.

The following table includes information on the alarms of the status displays. If the hard disk drive is defective and the SIMATIC monitoring software is installed, the LEDs of the status display light up individually or simultaneously.

Internal hard disk drive or hard disk drive in the removable tray

Status display	RAID BIOS	RAID software	Data cable connection	Drive
HDD0 alarm	Port 0	Device port 0	0	0
HDD1 alarm	Port 1	Device port 1	1	1

Mounting locations for hard disk drives in the RAID5 system

Unlike a RAID1 system, hard disk drives can only be installed on the front in the removable tray for a RAID5 system.

Note

Replacement of a hard disk drive in the removable tray and in the RAID system can be performed without switching off the device.

The new hard disk drive can be integrated into the RAID5 system at operating system level with the RAID software. Synchronization may take several hours, depending on system load.

The following figure shows a RAID5 system with three hard disk drives as an example and a hot spare hard disk drive in the removable tray.

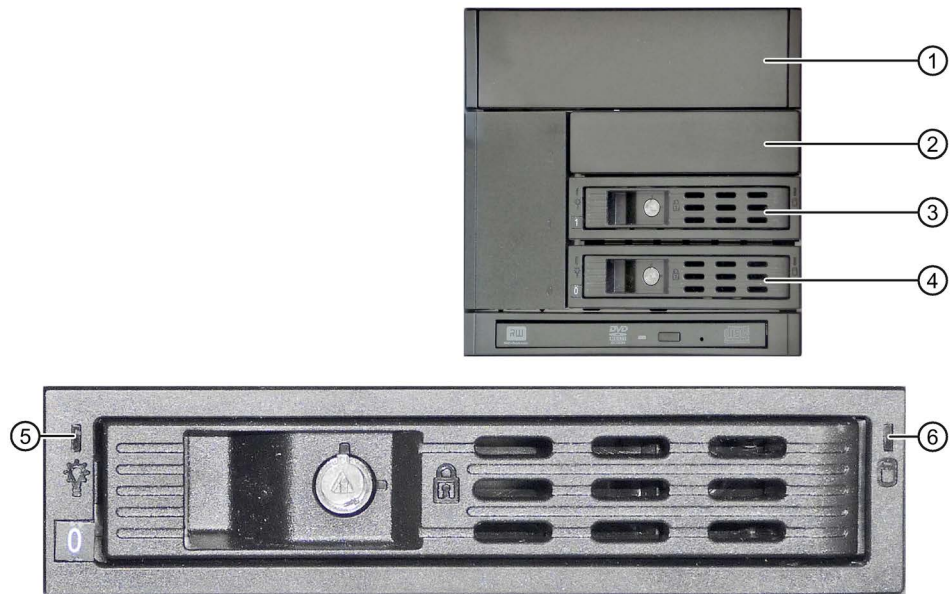

Similar to figure

- ① Slot for removable tray 3
- ② Slot for removable rack unit 2
- ③ Removable tray 1
- ④ Removable tray 0
- ⑤ "Power" LED; power supply available
- ⑥ "HDD" LED, access to hard disk drive

Status displays of the hard disk drives in a RAID5 system

A defective hard disk drive in the RAID system is displayed by the status displays at the front of the device.

The following table includes information on the alarms of the status displays. If the hard disk drive is defective and the SIMATIC monitoring software is installed, the LEDs of the status display light up individually or simultaneously.

Status display	RAID BIOS	RAID software	Data cable connection	Drive
HDD0 alarm	Port 0	Device port 0	0	0
HDD1 alarm	Port 1	Device port 1	1	1
HDD2 alarm	Port 2	Device port 2	2	2
HDD3 alarm	Port 3	Device port 3	3	3

Replacing a defective hard disk drive in the RAID system

1. Determine which hard disk drive has been reported as defective by the RAID software (HDD on port 0, 1, 2 or 3).
2. Remove the defective hard disk drive (internal drive or drive in the removable tray).
3. Replace the defective hard disk with a hard disk of the same type and capacity.

6.6.6 Inserting the 5.25" drive in the drive cage type B

Requirement

- The device is equipped with the drive cage type B.
- The device is fully disconnected from the mains voltage; see section "Switching off the device (Page 53)".
- The device is open.
- T10 screwdriver

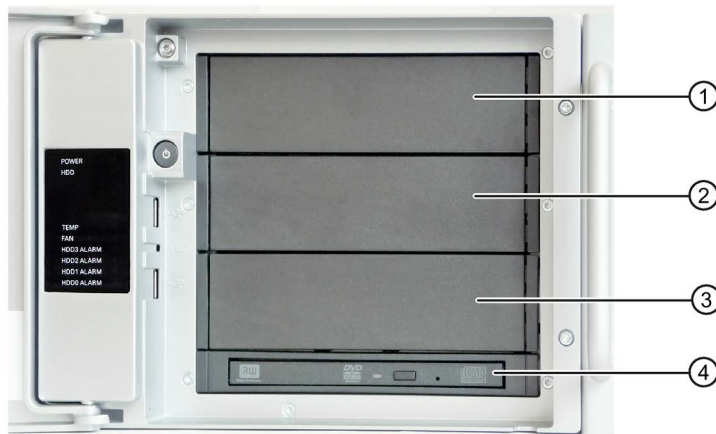

- ① 5.25" drive slot 2
- ② 5.25" drive slot 1
- ③ 5.25" drive slot 0
- ④ DVD slimline drive in the DVD slot

Procedure

Installing a drive

1. Remove the drive cover of the free slot, see section "Removing and installing a 3.5"/2.5" drive in drive cage type B (Page 71)" or "Removing and installing the hard disk or SSD in the removable tray (Page 74)".



2. Remove the drive bay cover ① (front) together with the right and left drive mounting bars ② from the slot.
3. Remove the left and right drive mounting bars ① from the side and the drive bay cover from the front ②.

Note: The mounting bars are labeled "L" and "R" and have to be installed in the same way again on the "left" and "right".

4. Screw the right ② and left ③ drive mounting bars to the new drive. Take care not to touch the contacts of the drive when you do this. The drive bay cover ① is no longer required.
5. Carefully insert the new drive with the mounting bars into the drive cage from the front and push it evenly, without tilting, in the guide rail on the left and the right until it snaps into place at the back.

Replacing the drive

1. Unlock the drive by pressing laterally against the surfaces ① and pushing the drive forward from the device in the direction of the arrow ②. Set the drive down carefully.

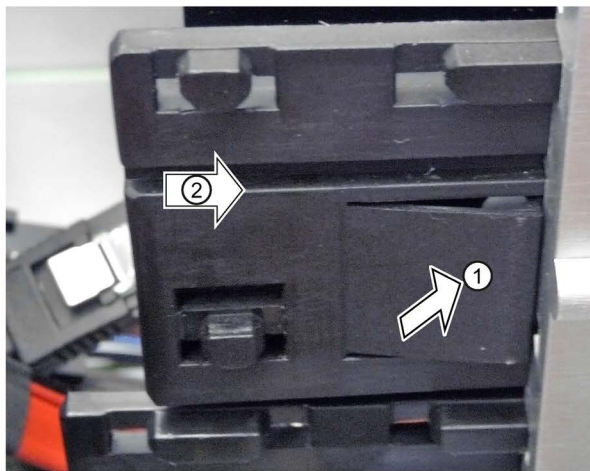

2. Proceed as described in the section "Inserting a drive" from step 3 onwards.

6.6.7 Removing and installing a DVD drive

Requirement

- The device is fully disconnected from the mains voltage; see section "Switching off the device (Page 53)".
- The device is open.

The following figure shows the position of the DVD drive in the drive cage type A ① and type B ②.



Procedure

1. Remove all SATA cables from the cable holder ①.

The outlined segment is enlarged in the next figure.

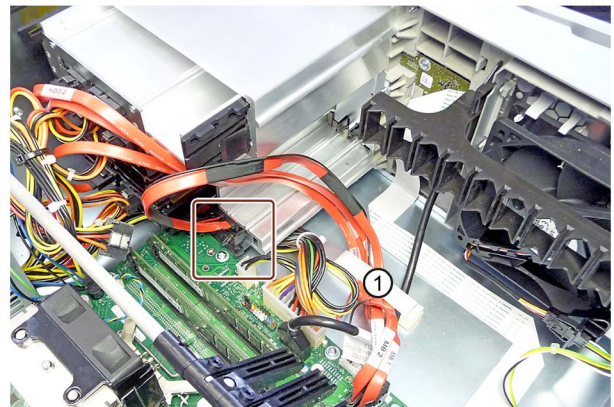

6.6 Drives

2. Unlock the DVD drive bay by pressing against the movable areas ② in the direction of the arrow, keeping the areas pressed and at the same time pushing the drive bay in the direction of the arrow slightly to the front with all connected cables.
3. Grip the front of the DVD ③ drive on the left and the right and pull it completely out of the device.
4. Carefully set down the DVD drive in the drive bay ④, as shown.
5. Remove the SATA connector ⑤ from the DVD drive.

Plug the SATA connector into the DVD drive again. Take care not to touch the contacts when you do this.

6. Push the drive bay into the installation slot ⑥ from the front until it snaps into place at the back.
7. Place all the SATA cables into the cable holder ① and close it.

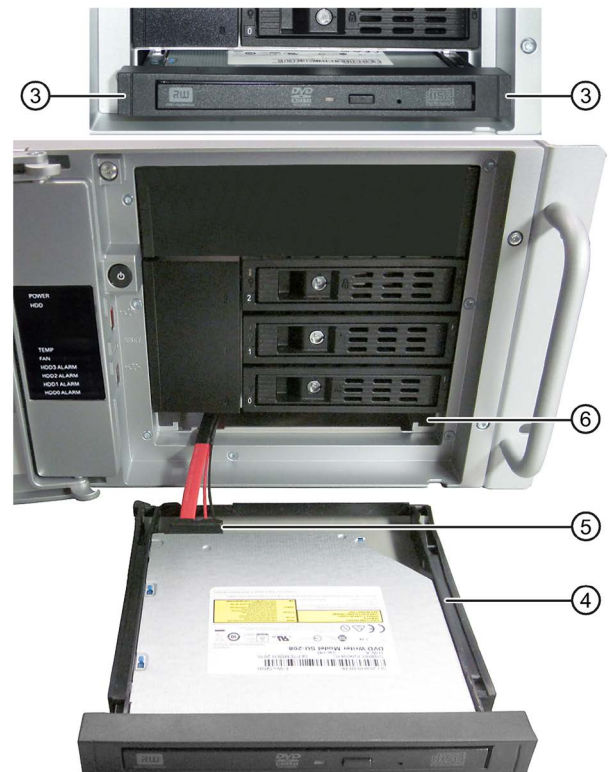
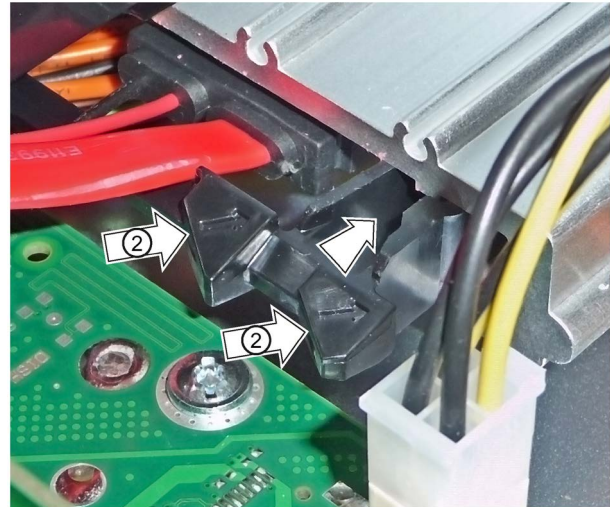

See also

Removing and installing a 3.5"/2.5" drive in drive cage type B (Page 71)

Device maintenance and repair

7.1 Repair information

Carrying out repairs

Only qualified personnel are permitted to repair the device.

 WARNING
Unauthorized opening and improper repairs on the device may result in substantial damage to equipment or endanger the user.
<ul style="list-style-type: none">• Always disconnect the power plug before you open the device.• Only install system expansion devices designed for this device. If you install other expansion devices, you may damage the device or violate the safety requirements and regulations on RF suppression. Contact your technical support team or where you purchased your PC to find out which system expansion devices may be installed.

If you install or exchange system expansions and damage your device, the warranty becomes void.

 CAUTION
Electrostatic sensitive devices (ESD)
The device contains electronic components which are destroyed by electrostatic charges. This can result in malfunctions and damage to the machine or plant.
Make sure you take precautionary measures even when you open the device, for example, when opening device doors, device covers or the enclosure cover. For more information, please refer to the chapter "ESD directives".

Limitation of liability

All technical specifications and approvals of the device only apply if you use expansion components that have a valid CE approval (CE mark). The installation instructions for expansion components in the associated documentation must be observed.

UL approval of the device only applies when the UL-approved components are used according to their "Conditions of Acceptability".

We are not liable for functional limitations caused by the use of third-party devices or components.

Tools

You can make repairs on the device with the following tools:

- T20 screwdriver for protective conductor connection and enclosure
- T6 screwdriver for removing and installing the DVD drive
- T10 screwdriver for all of the remaining screws

See also

ESD guideline (Page 127)

Spare parts and repairs (<http://support.automation.siemens.com/WW/view/en/16611927>)

7.2 Maintenance

7.2.1 Maintenance intervals

To maintain high system availability, we recommend the preventative replacement of those PC components that are subject to wear in accordance with the intervals for replacement indicated in the table below.

Component	Replacement interval
Drives	3 years
Backup battery	5 years
Fan	3 years
Filter pad	Depending on the degree of soiling

7.2.2 Remove the fan cover

Procedure

1. Open the front door (see "Opening the front door (Page 67)") until the marked lock releases the fan cover.
2. Take hold of the recessed grip.
3. Open the fan cover in the direction of the arrow.

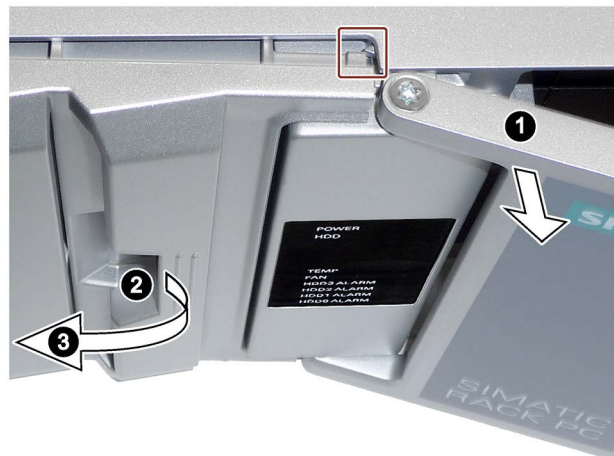

7.2.3 Replacing filters

The filter pad is located behind the fan cover.

Note

You may only use filters of the same type. Information about the original spare parts for SIMATIC PCs is available in the Internet at SIMATIC IPC after-sales information system (<http://www.siemens.com/asis>).

Filter pads are available as a pack of 10 under the article number A5E37019277.

Requirement

- The device is disconnected from the power supply, see section "Switching off the device (Page 53)".
- The front door is open, see section "Opening the front door (Page 67)".
- The fan cover has been removed, see section "Remove the fan cover (Page 90)".
- A filter pad from the pack of 10 A5E37019277

Procedure

1. Remove the filter pad from the fan cover.
2. Insert the new filter pad into the fan cover. It is inserted loosely in the fan cover. When you insert the filter pad, make sure it lies evenly in the fan cover.
3. Replace the fan cover.

Note

Use of the filter pad

We advise against using filter pads that have already been used. If you do want to refit a filter pad you have removed, however, take account of the direction in which the fan draws air into the device. Make absolutely certain that you do not fit the outer side of the filter pad on the inside. Generally, the outer side is clearly dirty after it has been in use for some time.

7.3 Manage onboard RAID system

The RAID system is fully set up ex works. The installed SIMATIC diagnostic software is used to display the status of the RAID system. Additional software is not required. Additional information is available in the sections "RAID systems (Page 50)" and "Replacing a defective hard disk drive in the RAID system (Page 81)".

You can configure RAID hardware using <CTRL+I> in the boot phase. The associated description is available on the "Documentation and Drivers" DVD.

7.3.1 Example for a RAID1 system during the boot phase of the system

```
Intel(R) Rapid Storage Technology - Option ROM - XXXXXXXXXX
Copyright(C) 2003-13 Intel Corporation. All Rights Reserved.

RAID Volumes:
ID   Name           Level           Strip           Size Status      Bootable
0   Volume0        RAID1(Mirror)   N/A             931.5GB Normal        Yes

Physical Devices:
Port Device Model      Serial #           Size Type/Status(Vol ID)
0   XXXXXXXXXX XXXXXXXXXX 728.0GB Member Disk(0)
1   XXXXXXXXXX XXXXXXXXXX 728.0GB Member Disk(0)

Press <CTRL-I> to enter Configuration Utility...
```

7.3.2 Example for a RAID5 system during the boot phase of the system

```
Intel(R) Rapid Storage Technology - Option ROM - XXXXXXXXXX
Copyright(C) 2003-13 Intel Corporation. All Rights Reserved.

RAID Volumes:
ID   Name           Level           Strip           Size Status      Bootable
0   Volume0        RAID5(Parity)   64KB            1000.0GB Normal        Yes

Physical Devices:
Port Device Model      Serial #           Size Type/Status(Vol ID)
0   XXXXXXXXXX XXXXXXXXXX 728.0GB Member Disk(0)
1   XXXXXXXXXX XXXXXXXXXX 728.0GB Member Disk(0)
2   XXXXXXXXXX XXXXXXXXXX 728.0GB Member Disk(0)

Press <CTRL-I> to enter Configuration Utility...
```

7.3.3 RAID software

The RAID software "Intel Rapid Storage Technology" offers advanced functions to use and manage the RAID system.

1. Select the RAID software via "Start > Programs > Intel Rapid Storage Technology".

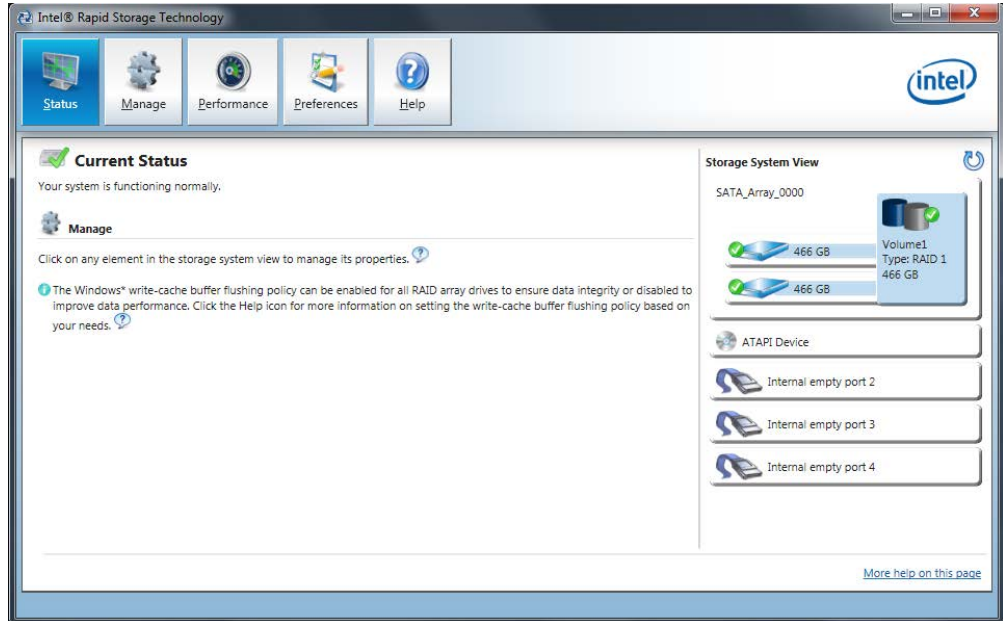

2. Select "Manage" > "Advanced" to display details of the RAID system.
3. Select "Help" > "System Report" > "Save" to create a report with the details of the RAID system.

7.3.4 Checking the status of the RAID system

By default, the status of the RAID system is displayed in the Windows Event Viewer and in a log file of the program. If an error occurs, a hard disk can be synchronized at the operating system level.

Note

It may take a very long time (hours or even days in the case of a high drive load) to synchronize a new hard disk in the background, depending on its size and on the system load.

The redundant system state is reached again only after synchronization is completed.

NOTICE

Operator errors on the machine or plant

Data is synchronized if a hard disk fails. Depending on the work load of the processor and hard disks, the system may react with some delay. Execution of keyboard, mouse or touch screen commands may be briefly delayed in extreme situations. This could result in operator errors on the machine or plant.

Do not operate safety-critical functions when a hard disk has failed.

7.3.5 Displaying a defective hard disk of a RAID system in the RAID software

Note

Always replace the defective hard disk with a new hard disk of the same type and capacity.

If an error is detected the defective hard disk must be replaced with a new hard disk to return to a secure RAID status after an error.

The RAID software indicates the following:

- A defective hard disk
- Details of the functioning hard disk:

The functioning hard disk is indicated by BIOS with its port number or by the RAID software with its device port number.

The following figure shows the corresponding window in the RAID software with a RAID1 system.

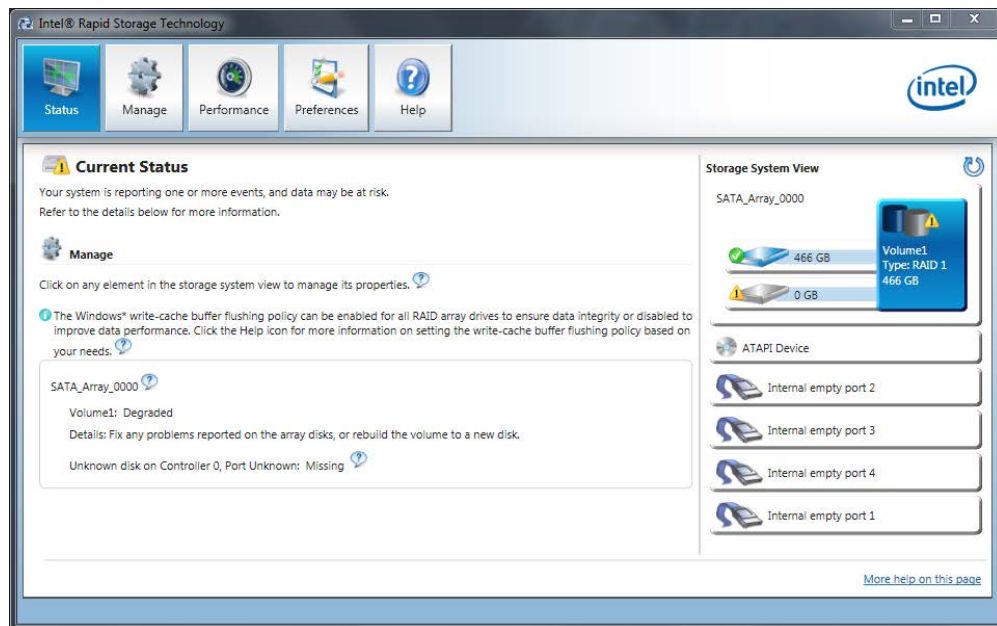

You can find information on how to detect and replace a defective hard disk in the RAID system in the section "Replacing a defective hard disk drive in the RAID system (Page 81)".

7.3.6 Special feature: Replacing hard disk in the RAID system when switched off

The RAID system does not automatically boot up when restarted if a defective hard disk was replaced while the RAID system is switched off. Therefore, place the RAID system in the first place of the bootable sources in the BIOS setup menu "Boot". Otherwise, the system will boot from the hard disk you have just installed and the message "Operating system not found" will be displayed.

7.3.7 Integrating a new hard disk drive in the RAID system

The RAID system is configured in the delivery state so that a new hard disk must be integrated manually when a defective hard disk was replaced.

However, you can configure the RAID system for automatic integration of a new hard disk after replacement of a defective hard disk.

RAID systems with a hot-spare hard disk are configured so that the hot-spare hard disk is automatically integrated in the event of an error.

Configuration of the automatic integration of a new hard disk (prior to replacing a defective hard disk)

NOTICE
Risk of data loss
If a new hard disk is automatically integrated in case of an error, the new hard disk is not checked for partition information or existing data.
All partitions and data on the new hard disk are erased without warning.
Only use a brand-new hard disk or a hard disk that is configured as a replacement drive. Notes on creating spare drives are available in the controller documentation.

1. Select "Start" > "Programs" > "Intel Rapid Storage Technology".
2. Select the "Preferences" menu.
3. Go to the "Automatic Rebuild" area and activate the "Auto-rebuild on hot plug" option.

Configuration of the manual integration of a new hard disk (prior to replacing a defective hard disk)

The RAID system is configured in the delivery state so that a new hard disk must be integrated manually when a defective hard disk was replaced.

You can configure the manual integration of the hard disk or check the settings yourself.

1. Select "Start" > "Programs" > "Intel Rapid Storage Technology".
2. Select the "Preferences" menu.
3. Go to the "Automatic Rebuild" area and deactivate the "Auto-rebuild on hot plug" option.

Manual integration of the hard disk (in the event of an error)

1. Select "Start" > "Programs" > "Intel Rapid Storage Technology".
2. Click  "Run Hardware Scan now".

The new hard disk is found and displayed.

Click on the link "Rebuild to another Disk".

Or:

1. Reboot the device.

The RAID software automatically integrates the hard disk.

2. Click on the link "Rebuild to another Disk".

Synchronization of the RAID system is initiated after clicking the link "Rebuild to another disk".

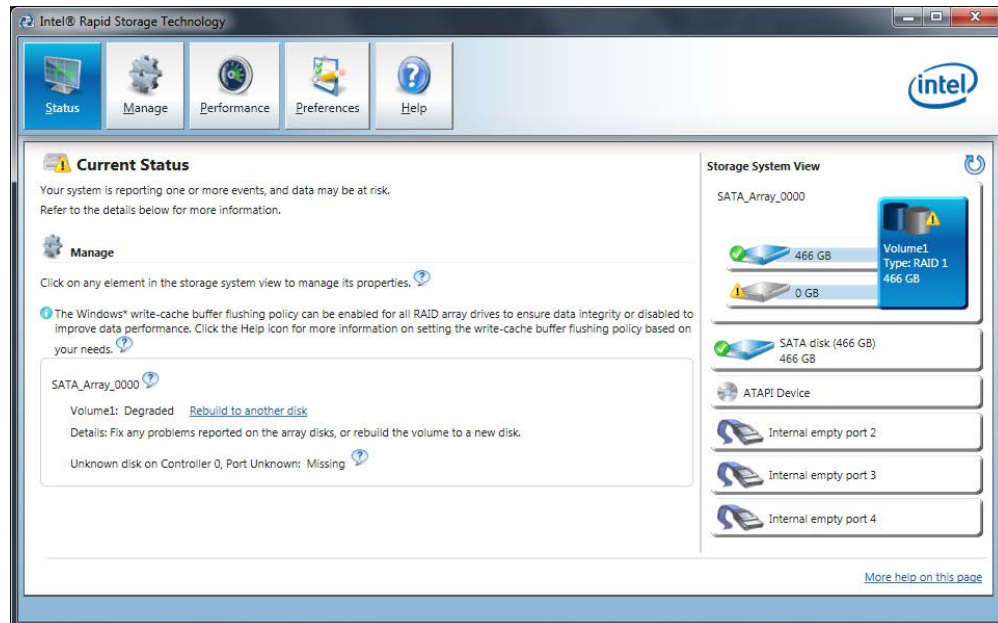

Display of the defective hard disk in the RAID software (in the event of an error)

The defective hard disk being replaced remains displayed in the RAID software during the rebuild process. The defective hard disk is no longer displayed when the rebuild process is complete.

1. Select "Start" > "Programs" > "Intel Rapid Storage Technology".
2. Select the "Status" menu.

The illustration below shows an example of the automatic rebuild process for a RAID1 system.

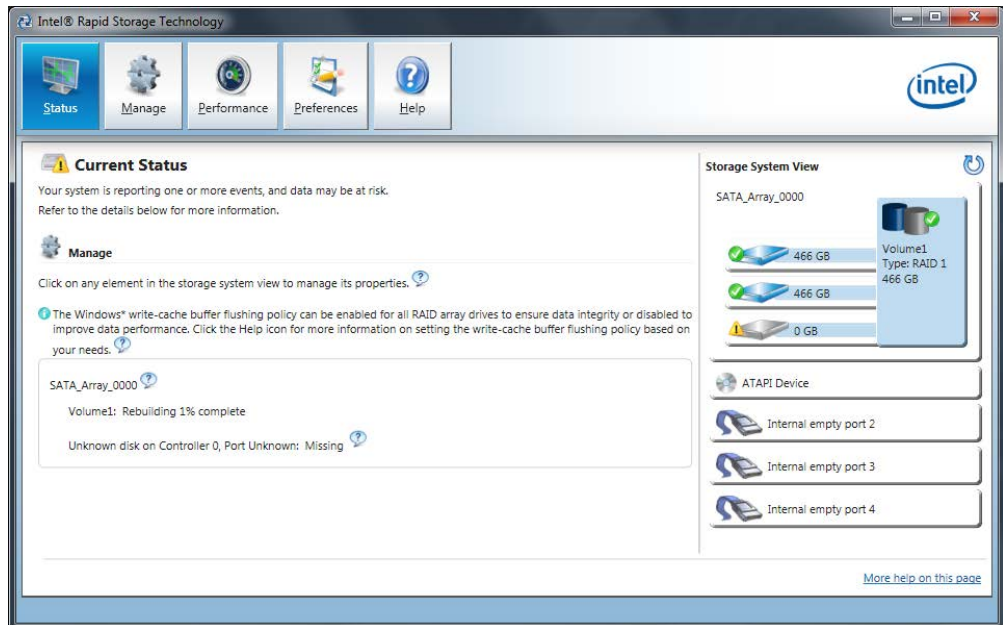

If you shut down and restart the system without installing a functioning new hard disk, "unused" is displayed for the corresponding SATA port. You can install the functioning hard disk while the system is running. The new hard disk is then assigned to a SATA port and is integrated into the RAID system.

7.3.8 Integrating a hot spare hard disk drive in the RAID system

If the hot spare hard disk drive was replaced in a RAID system, the new hot spare hard disk drive must be integrated in the RAID system once again.

Requirement

A hot spare hard disk drive was replaced in the RAID system, see section "Replacing a defective hard disk drive in the RAID system (Page 81)".

Procedure

1. Select "Start" > "Programs" > "Intel Rapid Storage Technology".

The RAID system is configured in the delivery state in such a way that a new hot-spare drive is automatically integrated.

If the automatic integration of a hard disk in the RAID system is deactivated, the hard disk must be integrated manually as described below.

2. Click  "Run Hardware Scan now".

The new hard disk is found and displayed.

3. Use the right mouse button to mark the new hard disk and select the menu item "Mark Disk as Spare" in the context menu.
4. Confirm the alarm in the "Mark Disk as Spare" window with "Yes".

7.4 Removing and installing hardware

7.4.1 Removing the device fan

7.4.1.1 Changing the front fan

Requirement

- The device is fully disconnected from the mains voltage; see section "Switching off the device (Page 53)".
- The fan cover has been removed; see section "Remove the fan cover (Page 90)".
- A fan
 - Use only a fan of the same type.

Procedure

Remove the fan support

1. Press the locks ① together and keep them pressed.
2. Lift the fan support ② slightly upwards from the bayonet fitting and remove it to the front from the front of the enclosure.
3. Put down the fan support with the openings facing down (fan is above, see following figures).

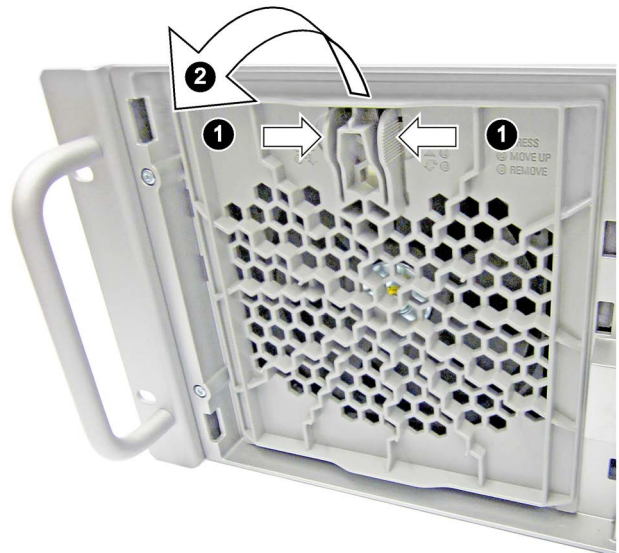

Replace the fan in the fan support

1. Press on the clip on the small fan cable plug connector ① and remove the connector from the larger adapter plug ②.
2. Press on the side of the clips ② and loosen the adapter plug from the cable holder.
3. Loosen the locking latches ③ of the fan support at the front and rear and remove the fan.
4. Loosen the locking latches ④ of the cable holder and remove the cable holder.

Place the cable holder on the new fan as shown. Use the highlighted positions as a guide.

Snap the cable holder into place.

5. Place the new fan on the fan support as shown. Use the highlighted positions as a guide.

Snap the new fan into place in the locking latches ⑤.

6. Install the adapter connector ② of the fan cable in the cable holder.
7. Insert the small fan cable connector ① in the adapter connector again.
8. Mount the fan support in the enclosure (see above).

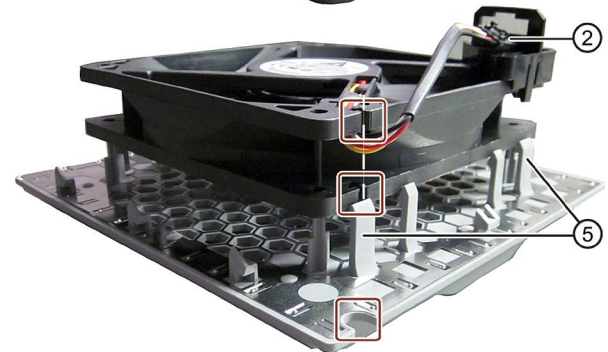
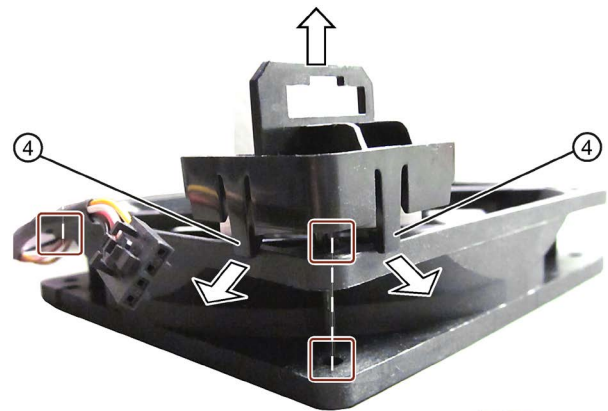
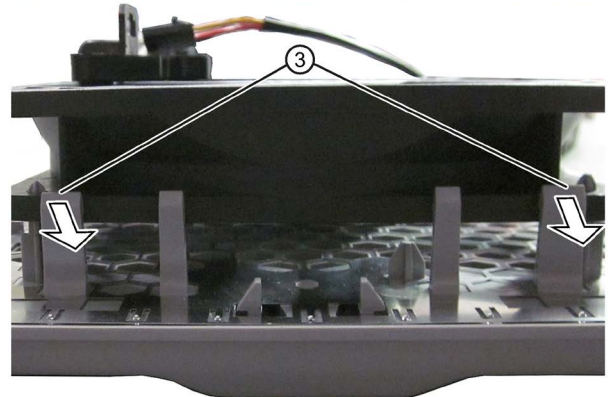
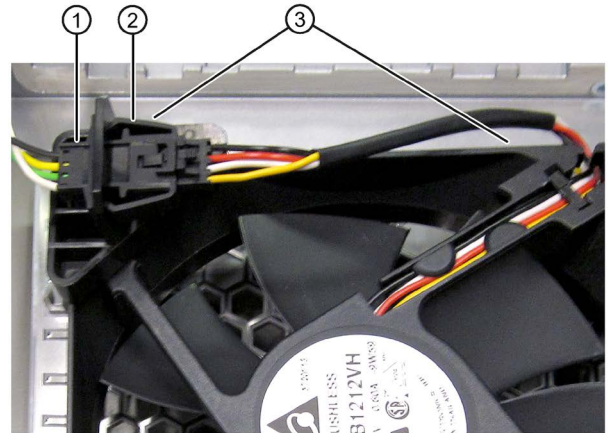

7.4.1.2 Change the fan on drive cage type A

The fan is only installed in the removable tray (drive cage type A) for configurations with RAID and the hard disk type "Enterprise".

Requirement

- The device is fully disconnected from the mains voltage; see section "Switching off the device (Page 53)".
- The device is open; see section "Open the device (Page 67)".
- 5.25" adapter for removable rack unit in slot 3 has been removed; see section Installing a hard disk or SSD in slot 3 (Page 78)
- A fan
Use only a fan of the same type.

Procedure

1. Detach the fan cable from the motherboard.
2. Press the upper and lower lock in the direction of the arrow, remove the fan support from the drive cage and put it down as shown.

Note: The fan holder is labeled as follows:

- At the top ② with "Top"
- At the bottom ② with arrows which indicate the direction of rotation and air flow of the fan.

3. Bend the locking latches of the fan support slightly outwards and remove the fan from the fan support.
4. Place the new fan in the fan support as shown. Use the cable outlet ④ as a guide, it must lie on the highlighted recess through which you guide the fan cable.

Finally, snap the new fan completely into place in the locking latches ③.

5. Mount the fan support on the drive cage (see above).
6. Connect the fan cable to the motherboard.

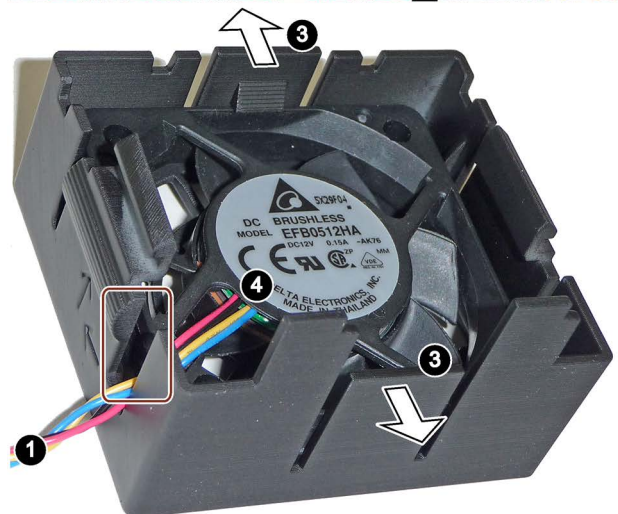
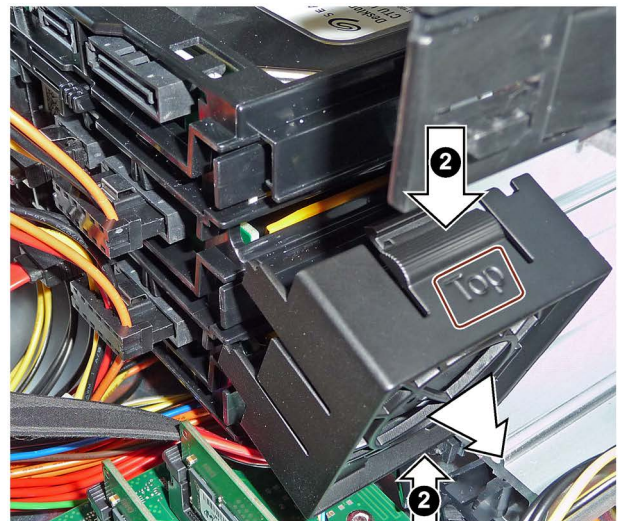

7.4.2 Replacing the backup battery

Note

Note the following points:

- Batteries are wearing parts.
Backup batteries should be replaced at intervals of 5 years in order to maintain PC functionality.
 - The configuration data of the device is deleted when the battery is replaced.
Note the current BIOS setup settings.
 - Dispose of used batteries in accordance with local regulations.
-

Requirement

- A lithium battery recommended by the manufacturer or one that is identical
Information on original spare parts for SIMATIC IPCs is available at SIMATIC IPC after-sales information system (<http://www.siemens.com/asis>).

Procedure

1. The location of the backup battery on the motherboard and the procedure for replacing it are described in the manual of the motherboard on the supplied "Documentation and Drivers" DVD.
2. Reset the BIOS setup.

See also

Battery monitoring (Page 58)

7.4.3 Removing the power supply

Requirement

- The device is fully disconnected from the mains voltage, see section "Switching off the device (Page 53)".
- The device is open, see the section "Open the device (Page 67)".
- T10 screwdriver
- Diagonal cutter

Procedure

1. Disconnect the cables from the drives and the motherboard.
2. Remove the cable ties securing the power cables in the enclosure.
3. Remove the four fixing screws that are marked in the figure below.



4. Pull the power supply upward and out of the housing.

7.4.4 Removing module of the redundant power supply

If a module of the redundant power supply is defective, you can continue to operate the device until the device can be shut down in a controlled manner.

Requirement

- Cross-tip screwdriver P1

Procedure



1. Use the LEDs to determine which module is defective (LED at the top of the module is not lit).
2. Switch off the device so that the power supply is switched off.
3. Remove the power cable of the defective module.
4. Remove the highlighted screw of the defective module.
5. Pull out the defective module at the handle.
6. Insert the new module and secure it with the highlighted screw.
7. Connect the power supply cable again.
8. Switch on the device.

See also

Switching off the device (Page 53)

7.4.5 Removing the redundant power supply

Requirement

- The device is fully disconnected from the mains voltage; see section "Switching off the device (Page 53)".
- The device is open; see section "Open the device (Page 67)".
- Modules of the redundant power supply are removed, see section "Removing module of the redundant power supply (Page 104)".
- T10 screwdriver

Procedure

Removal

1. Remove the cable ties securing the power cables in the enclosure.
2. Disconnect the cables from the drives and the motherboard.
3. Remove the highlighted screws inside the device enclosure.
4. Remove the highlighted screws.
5. Pull out the enclosure of the power supply from the IPC housing from the back.

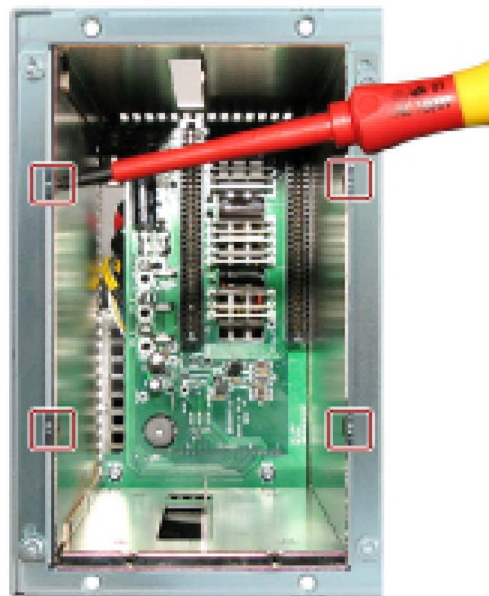
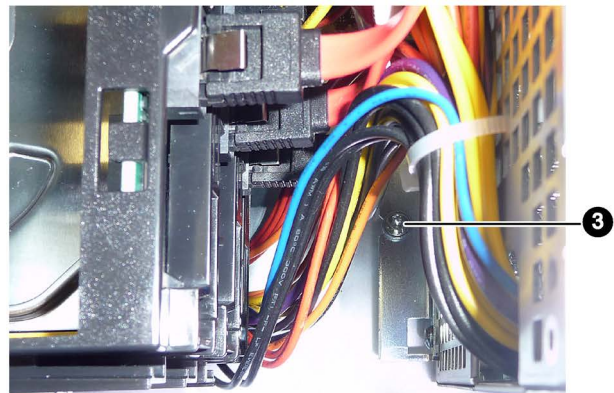

Installation

For installation, follow the steps for removal in reverse order.

7.4.6 Removing the motherboard

Requirement

- The device is fully disconnected from the mains voltage; see section "Switching off the device (Page 53)".
- The device is open; see section "Open the device (Page 67)".
- A motherboard
The motherboard as spare part is supplied without processor and memory modules.
- T10 screwdriver

Procedure

Removal

1. Remove the expansion cards from the slots, see chapter "Installing expansion cards (Page 69)".
2. Push the built-in 5.25" drives or 5.25" adapter for the removable tray to the front; see section "Drives".
3. Note the assignment of all cables to the motherboard.
4. Disconnect all cables from the motherboard.
5. Remove the screws that are marked in the figure below.

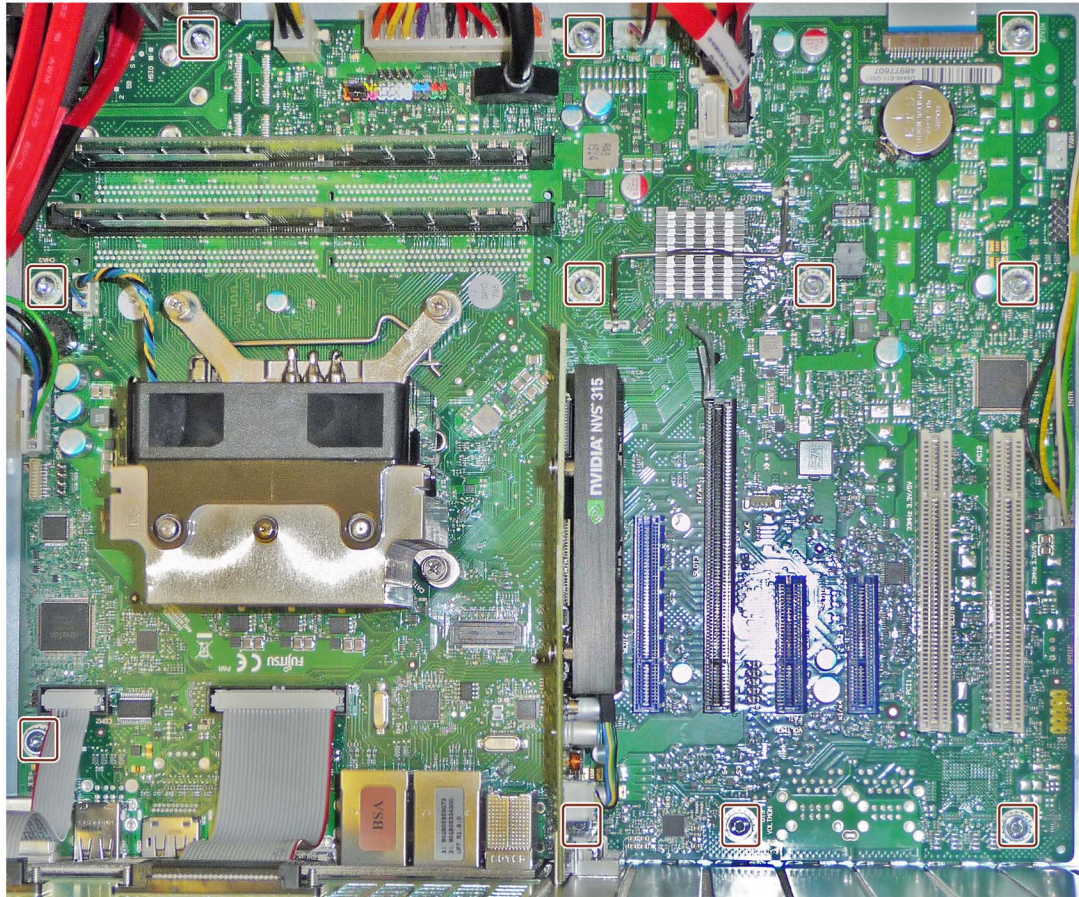

Installation

1. For installation, follow the steps for removal in reverse order.
2. Update the BIOS to match the version of the motherboard. Please note during the update if you operate a device with or without a RAID system.

7.4.7 Replacing the processor

Requirement

- The device is fully disconnected from the mains voltage; see section "Switching off the device (Page 53)".
- The device is open; see section "Open the device (Page 67)".
- A processor of the same type or an approved substitute type from the list of spare parts.

Only an approved processor is permitted to be installed on the motherboard of the device. Information about original spare parts for SIMATIC IPCs is available on the Internet at:

- SIMATIC IPC after-sales information system (<http://www.siemens.com/asis>)
- Contacts (<http://www.siemens.com/automation/partner>)

NOTICE
Damage to the processor
If the installed processor is operated with a higher clock frequency than permitted, it can be destroyed or cause loss of data.
Operate the processor only at a clock frequency that is equal to or less than the permitted clock frequency.

NOTICE
Motherboard and heat sink
The processor type Intel® Xeon® Processor E3-1275 v5 requires the motherboard D3446 A5E35996948 and the heat sink A5EA5E36981171.
If you use a processor of a type that differs from the one originally installed, perform a BIOS update. The microcode matching the processor is loaded.

- Manual of the motherboard on the supplied "Documentation and Drivers" DVD.

Procedure

Removal

1. Remove the highlighted fan connector and loosen the four highlighted screws.

The following figure shows the motherboard D3446 with the heat sink for the Xeon processor.



2. Remove the heat sink.
3. Unlock the socket and lift the socket cover.



4. Remove the processor.

Installation

1. Install the new processor on the socket, as shown in the figure.

During positioning, make sure to take the highlighted arrow on the processor into consideration.

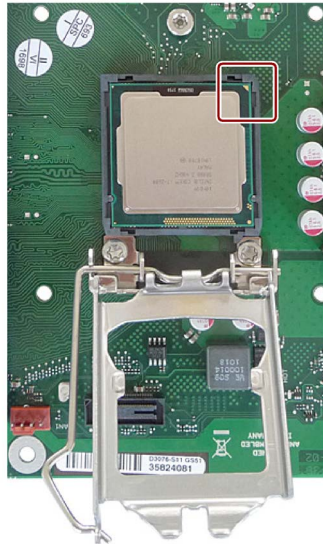

The rest of the procedure is described in the manual for the motherboard on the supplied "Documentation and Drivers" DVD.

7.4.8 Replace the adapter module for the removable tray

Requirement

- The device is equipped with the drive cage type A.
- The device is fully disconnected from the mains voltage; see section "Switching off the device (Page 53)".
- The device is open; see section "Open the device (Page 67)".
- All slot covers and removable trays have been removed.

Procedure

Removal

1. Note the assignment of all SATA cables and detach all the SATA cables ①.
2. Unlatch the adapter module for the removable rack unit by firmly pressing on the latches ② in the direction of the arrow and pressing on the ejector ③.
3. Loosen the unlatched adapter module ④ by rotating it upwards from the brackets and take it out of the drive cage.

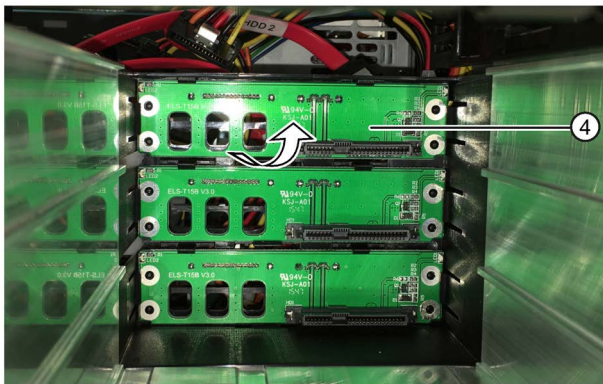
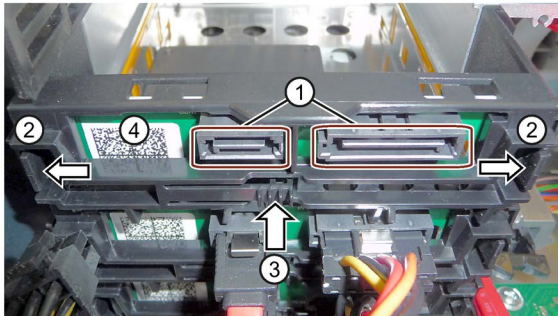

Installation

1. Insert the new adapter module for removable rack unit ④ into the drive bay from the front and snap it into place at the back, see section "Installing a hard disk drive or SSD in slot 0 to 2 (Page 76)".

7.4.9 Changing drives

See section "Drives (Page 71)".

7.5 Installing the software

7.5.1 Sources for installation of the operating system

If the operating system is faulty, you can reinstall it with one of these DVDs:

- With the recovery DVD and "Documentation and Drivers" DVD

The recovery DVD is included in the scope of delivery when you have ordered a device with operating system. The recovery DVD includes:

- The installation program for installing the operating system with the supported languages
- The tools for setting up the drives

The basic language of the installed operating system is English. If additional languages are required, install these from the recovery DVD.

The "Documentation and Drivers" DVD contains the documentation and the hardware drivers.

- From the Restore DVD

The Restore DVD is included in the scope of delivery when you have ordered a device with operating system. The DVD contains an image file with the following software:

- Operating system with installed hardware drivers
- Monitoring software, e.g., DiagBase.

Note

Only an extended restore DVD is available for Windows 10.

7.5.2 Updating the operating system

Windows

The latest updates for the Windows operating system are available on the Internet at Microsoft (<http://www.microsoft.com>) and on the device in the Start menu "Start > All Programs > Windows Update > Check for updates".

Note

Before you install new drivers or operating system updates for Windows MUI versions, configure the regional menu and dialog settings and the default English (US) language.

other operating systems

Contact the corresponding manufacturer.

7.5.3 Installing drivers and software

Requirement

You need the "Documentation and Drivers" DVD included in the scope of delivery to install Windows drivers.

Procedure

Installing drivers

1. If your device has no DVD drive, connect an external USB DVD drive to a USB port.
2. Insert the supplied "Documentation and Drivers" DVD.
3. Start the "Start" program.
4. Accept the licensing conditions.
5. Select "Drivers" from the index.
6. Select the device and operating system.
7. Select the required driver.
8. Open the folder with the driver data. Click on the link next to "driver path".
9. Start the setup program in this folder.

Note

The driver for the chepset must be installed first with a new Windows installation. Then you can install the drivers of all other devices.

Installing the software

- You can find information about installing SIMATIC software packages in the corresponding documentation.
- You can obtain information about driver updates and installing application programs from the respective manufacturers.

7.5.4 Installing Windows

Note

Specific information on using the Windows operating systems is available on the Internet:

- Microsoft Technet Windows (<http://technet.microsoft.com/windows>)
 - Microsoft Technet Windows Server (<http://technet.microsoft.com/windowsserver>)
-

Requirement

You need the Recovery DVD for the operating system you want to install. This is included in the product package if you have ordered a device with an operating system.

If you use storage controllers that are unknown to the operating system, for example a RAID or AHCI controller, copy the respective controller driver to a USB stick and keep this USB stick to hand. The controller driver is required during installation.

Note

Operation of older operating systems with USB keyboard and mouse

Select the "PS/2 Emulation" setup parameter in the "Advanced > USB Configuration" menu of the BIOS Setup if you are using the USB keyboard and USB mouse for the following:

- Recovery of Windows 7 and Windows Server 2008 R2
 - Update of USB driver in installed Windows 7 and Windows Server 2008 R2
-

Use of the Trusted Platform module TPM 2.0 under Windows 7, Windows Server 2008 R2 and 2012 R2

If you install the operating system yourself, the following requirements must be met:

- The operating system is installed and booted with the setting "UEFI Boot Type".
During installation the drive is set up as a GBT partition.
- Hotfix KB2920188 has been installed More information can be found on the Microsoft homepage "Support for TPM 2.0 (<https://support.microsoft.com/en-us/kb/2920188>)".

Procedure

1. If your device has no DVD drive, connect an external USB DVD drive to a USB port.
2. Insert the Recovery DVD into the DVD drive.
3. Reboot the device.
4. Press the <F12> key when the device boots and keep it pressed.

The boot menu is displayed after initialization is completed.

5. Select the optical drive using the cursor keys.

To boot the recovery DVD in "UEFI" mode, in the "Boot" menu in BIOS setup select the item for which the optical drive is identified with "UEFI" in front of the name.

- Requirement: In the "Advanced > CSM Configuration" BIOS menu, the parameter "Boot option filter" is set accordingly.
- Your data storage medium will be set up with GPT partition management during installation of Windows. Example:

UEFI: TSST corp CDDVDW SU-208HB

6. Confirm the selection by pressing ENTER.
7. **Immediately** press any key when you see the following prompt to install the operating system from the Recovery DVD.

```
Press any key to boot from CD or DVD ..
```

After a few seconds, you will see the "Install Windows" installation program.

8. Now follow the instructions in the installation program.

You can find additional information on this in the next section.

"Install Windows" installation program

The language of the installation program and the operating system is preset to English. You can change the language of the operating system after the installation. Information on this topic is available in the section "Setting up the language selection using the Multilanguage User Interface (MUI)".

Setting up partitions and integrating storage controllers unknown to the operating system

You can set up partitions during the installation process and integrate storage controllers that are unknown to the operating system. To do so, select "Custom (advanced)" when prompted for the installation type in the "Install Windows" installation program.

The following dialog boxes are available, for example:

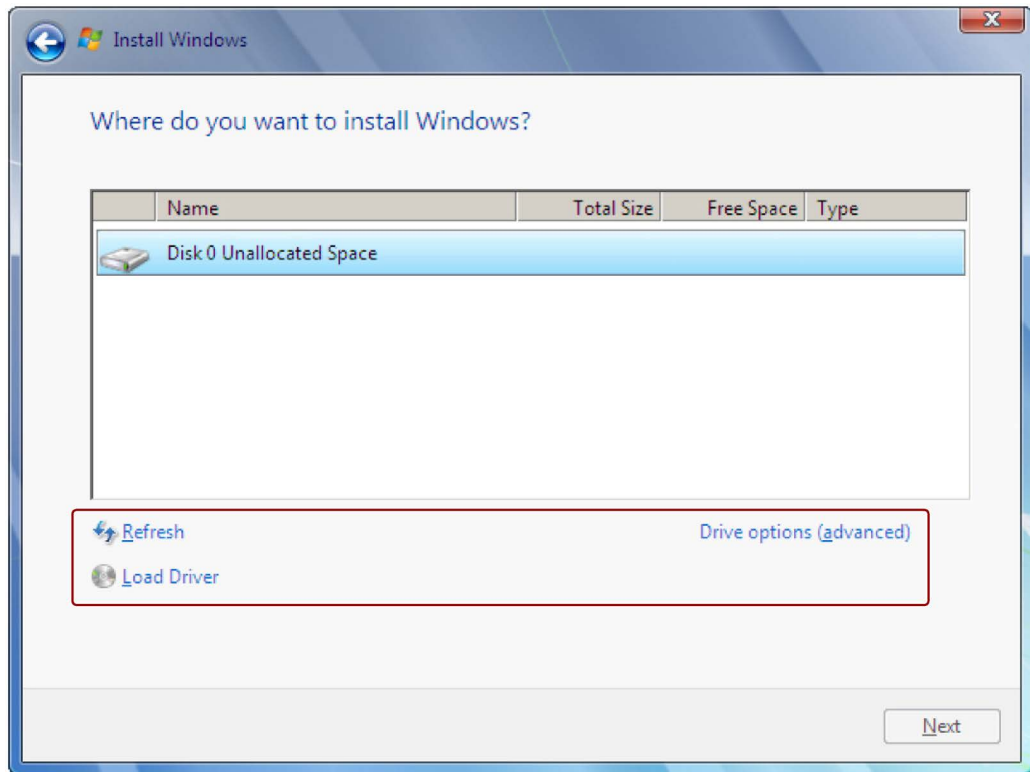

Refresh	Updating
Load Driver	Integration of controller drivers unknown to the operating system and required for installation. Please read the information in the section "Information for systems with RAID or AHCI controller".
Drive options (advanced)	For display of additional functions that you can use to set up the data storage medium, see Windows installation window "Drive options (advanced)".

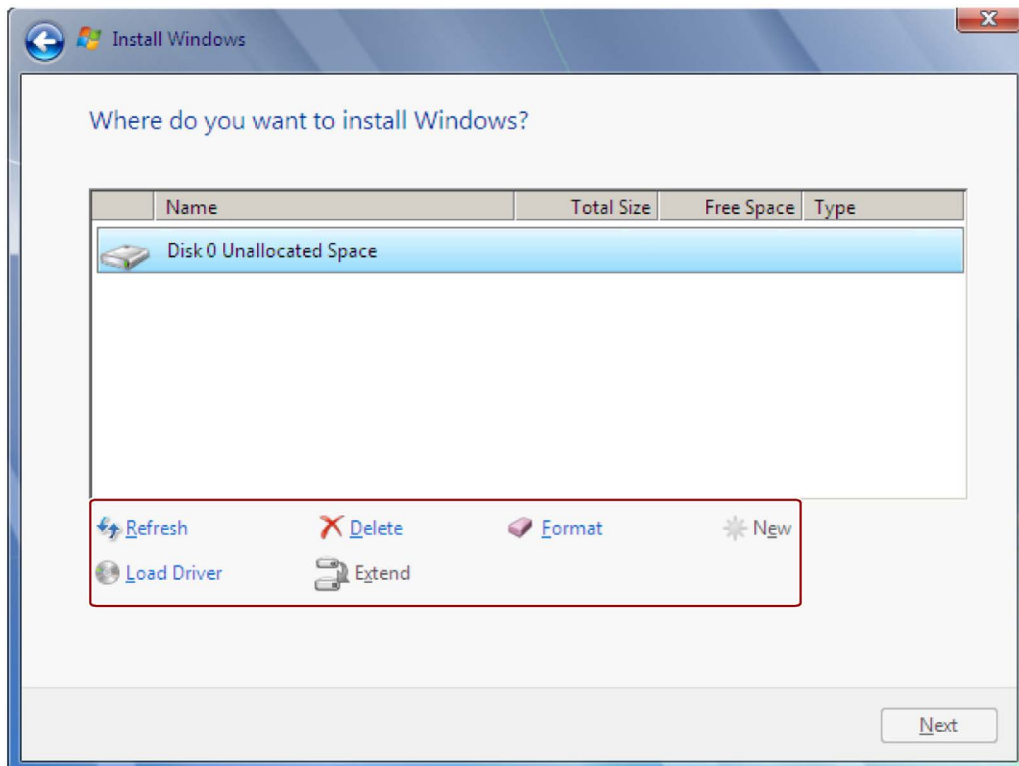

Refresh	Updating
Load Driver	Integration of controller drivers unknown to the operating system and required for installation. Please read the information in the section "Information for systems with RAID or AHCI controller".
Delete	Deleting a partition
Extend	Changing the partition size
Format	Formatting a partition
New	Creating new partitions
	Identification for error messages, for example, if the data medium was not formatted in the required "NTFS" format.

Note

If you want to install the operating system on a data medium connected to a storage controller unknown to the operating system, you have to integrate the driver of the storage controller. Integrate this driver before you partition the data medium and before you install the operating system. For more information on integrating the storage controller, refer to the section "Information for systems with RAID or AHCI controller".

1. Make sure that the partition on which you want to install the operating system is large enough and is set up with a NTFS file system.

The recommended minimum size of this partition varies depending on which operating system, how much work memory and which additional software you want to use. You can find information on how the data medium is partitioned in its factory state in the next section.

2. Select the partition on which you want to install the operating system.
3. Click "Next".

Installation is started. The Windows operating system is installed on the data medium.

Information for systems with RAID or AHCI controller

Data carrier controllers unknown to the operating system must be made known to the operating system prior to installation in the "Install Windows" installation program.

Requirement

You have copied the relevant controller driver to a USB stick.

Procedure

1. Connect the USB stick with the controller driver to the device.
2. Start the "Install Windows" installation program as described above.
3. Select "Load Drivers" in the Windows installation window.
4. Select the respective driver on the USB stick.

7.5.5 Partitions in the factory state

Partitions in the delivery state of Windows 7 and Windows Server 2008 R2

The following information applies to data storage media ≥ 200 GB.

Partition	Name	Size	File system
First	Boot	260 MB	FAT32, automatically set up by installation program
Second	MSR	128 MB	None, automatically set up by installation program
Third	System	160 GB	NTFS, not compressed
Fourth	Data	Remainder	NTFS, not compressed

Partitions in the delivery state of Windows Server 2012 R2

The following information applies to data storage media ≥ 200 GB.

Partition	Name	Size	File system
First	WinRE	300 MB	NTFS
Second	Boot	260 MB	FAT32, automatically set up by installation program
Third	MSR	128 MB	None, automatically set up by installation program
Fourth	System	160 GB	NTFS, not compressed
Fifth	Data	Remainder	NTFS, not compressed

Partitions in the delivery state of Windows 10

The following information applies to data storage media ≥ 200 GB. The partitions are fixed and cannot be changed during the course of installation.

Partition	Name	Size	File system
First	Boot	260 MB	FAT32
Second	MSR	128 MB	None
Third	System	160 GB	NTFS, not compressed
Fourth	WinRE	500 MB	NTFS, not compressed
Fifth	Data	Remainder	NTFS, not compressed

7.5.6 Setting up the language selection using the Multilanguage User Interface (MUI)

You can set the display of menus, dialogs or other information, such as date and time, to a different language. For this purpose, you can either select one of the preinstalled languages or install a new language package.

The following command sequences are described in English. Depending on the default setting, they can be displayed in another language.

Procedure

Changing the settings for language, region and formats of a registered user account

Windows 7 and Windows Server 2008 R2:

1. Choose:
"Start > Control Panel > Clock, Language, and Region > Region and Language"
2. You can make the desired changes in the "Formats", "Location" " and "Keyboards and Languages" tabs.

Windows 10 and Windows Server 2012 R2:

1. Choose:
"Start > Control Panel > Clock, Language, and Region > Region"
2. You can make the desired changes in the "Formats", and "Location" tabs.

Changing the settings for language, region and formats of the system account and the standard user account

You can change the settings for language, region and formats of the system account (for example, the language in the user login dialog) and the settings of the standard user account (standard setting for new users). The settings of the registered user are copied to the system account and the standard user account for this purpose.

Windows 7 and Windows Server 2008 R2:

1. Choose:
"Start > Control Panel > Clock, Language, and Region > Region and Language"
2. You can make the required changes in the "Administrative" tab. You copy the settings by clicking the respective button.

Windows 10 and Windows Server 2012 R2:

1. Choose:
"Start > Control Panel > Clock, Language, and Region > Region"
2. You can make the required changes in the "Administrative" tab. You copy the settings by clicking the respective button.

Installing language package

The available language packages are described in the product description in section "Features (Page 11)". Some language packages are available on the Recovery DVD in the "Languagepacks" folder.

Windows 7 and Windows Server 2008 R2:

1. Choose:
"Start > Control Panel > Clock, Language, and Region > Region and Language"
2. Select the "Keyboards and Languages" tab.
3. Click the "Install/uninstall languages" button and make the required changes.

Windows 10 and Windows Server 2012 R2:

1. Right-click the start menu in the task bar and select "Command Prompt (Admin)".
2. Enter the following command in the command line:

```
Dism /online /Add-Package /PackagePath:#Path to the language pack#
```

For "#Path to language pack#", enter the path to the language pack you want to install.

Example:

```
Dism /online /Add-Package /PackagePath:E:\Languagepacks\ja-jp\lp.cab
```

See also

Switching on the device (Page 45)

7.5.7 Restoring the delivery state

You can restore the original software using the Restore DVD. The DVD contains the necessary images and tools for transferring the software to the hard disk drive or SSD of your device.

The following options are available for restoring the delivery state:

- Restore the entire hard disk/SSD with drive C: and D:
- Restore drive C:

This means data stored on drive D: is retained.

Back-up authorization or license key

- Check whether you can back-up your authorization or license key from the drive and perform this procedure if possible.
- If backup is not possible, please contact Customer Support. There you can obtain information necessary for corresponding software authorization.

NOTICE

Risk of data loss

If "Restore system partition only" is set all data on drive C: (system partition) will be deleted. All data, user settings and all authorizations or license keys on drive C: are lost! All data on drive C: will be completely deleted, reformatted and overwritten with the original factory software.

ALL data, user settings as well as all authorizations or license keys on drive C: and D: etc. are lost if you select the "Restore entire hard disk" option.

Procedure

1. If your device has no DVD drive, connect an external USB DVD drive to a USB port.
2. Insert the Restore DVD into the DVD drive.
3. Reboot the device.
4. Press the <F12> key when the device boots and keep it pressed.

The boot menu is displayed after initialization is completed.

5. In the boot menu, select the optical drive using the cursor keys.

To restore a system which boots in "UEFI" mode, you must also boot the restore DVD using UEFI.

To boot the restore DVD in "UEFI" mode, select in the BIOS setup

- the appropriate setting in the "Advanced > CSM Configuration > Boot option filter" menu
- the entry for which the optical drive is identified with "UEFI" in front of the name in the "Boot" menu. Example:

UEFI: TSST corp CDDVDW SU-208HB

6. Follow the instructions on the screen.

Note

All existing data, programs, user settings, authorizations and license keys on the drives are deleted. The drives are setup as described in section "Partitions in the factory state".

Extended options of the Restore DVD of Windows

The Windows 10 Restore DVD provides two basic installation types:

Select an operating system version in the dialog window for this purpose:

- "Factory state": The factory state is completely restored.
- "Administrator Basic": The data storage medium is partitioned as in the factory state:
 - Windows is installed.
 - No settings from Siemens AG are provided.
 - No additional drivers and software are installed.

7.5.8 Installing onboard RAID controller software

You install the software of the onboard RAID controller with its driver, which can be found on the supplied DVD "Documentation and Drivers".

7.5.9 Updating USB drivers

You install the software of the USB controller with its driver, which can be found on the supplied DVD "Documentation and Drivers".

Note

Operation of older operating systems with USB keyboard and mouse

Select the "PS/2 Emulation" setup parameter in the "Advanced > USB Configuration" menu of the BIOS Setup if you are using the USB keyboard and USB mouse for updating the USB driver in installed Windows 7 and Windows Server 2008 R2.

7.5.10 Backing up data and changing partitions at a later time

We recommend the software tool SIMATIC IPC Image & Partition Creator to back up data under Windows operating systems. This tool provides convenient and efficient functions for backing up and quickly restoring the full content of data storage media and individual partitions (images).

SIMATIC IPC Image & Partition Creator supports the burning of DVD media. You can order the tool using the Siemens online ordering system Industry Mall (<https://mall.industry.siemens.com>). For more information on SIMATIC IPC Image & Partition Creator, refer to the corresponding product documentation.

Note

SIMATIC IPC Image & Partition Creator only supports the device hardware as of version 3.4.2. Data storage media set up with GPT partition management are supported as of version 3.4. Older versions do not support the device hardware.

For information on SIMATIC IPC Image & Partition Creator, refer to the corresponding product documentation.

7.6 Recycling and disposal

The devices described in these operating instructions can be recycled thanks to their low level of pollutants. Observe the local statutory requirements for environmentally sound recycling and disposal of your old devices. Alternatively, you can use a certified disposal service company.

Technical specifications

8.1 Certificates and approvals

ISO 9001 certificate

The Siemens quality management system for our entire product creation process (development, production and sales) meets the requirements of ISO 9001.

This has been certified by DQS (the German society for the certification of quality management systems).

Software license agreements

If the device is supplied with preinstalled software, you must observe the corresponding license agreements.

UL approval



The following approvals are available for the device:

- Underwriters Laboratories (UL) in accordance with Standard UL 60950-1 Second Edition, File E115352 (I.T.E.)
- Canadian National Standard CAN/CSA-C22.2 No. 60950-1-07 Second Edition

FCC and Canada

USA	
Federal Communications Commission Radio Frequency Interference Statement	This equipment has been tested and found to comply with the limits for a Class A digital device, pursuant to Part 15 of the FCC Rules. These limits are designed to provide reasonable protection against harmful interference when the equipment is operated in a commercial environment. This equipment generates, uses, and can radiate radio frequency energy and, if not installed and used in accordance with the instruction manual, may cause harmful interference to radio communications. Operation of this equipment in a residential area is likely to cause harmful interference in which case the user will be required to correct the interference at his own expense.
Shielded Cables	Shielded cables must be used with this equipment to maintain compliance with FCC regulations.
Modifications	Changes or modifications not expressly approved by the manufacturer could void the user's authority to operate the equipment.
Conditions of Operations	This device complies with Part 15 of the FCC Rules. Operation is subject to the following two conditions: (1) this device may not cause harmful interference, and (2) this device must accept any interference received, including interference that may cause undesired operation.
CANADA	
Canadian Notice	This Class B digital apparatus complies with Canadian ICES-003.
Avis Canadien	Cet appareil numérique de la classe B est conforme à la norme NMB-003 du Canada.

AUSTRALIA / NEW ZEALAND



This product meets the requirements of the standard EN 61000-6-3:2007 Generic standards - Emission standard for residential, commercial and light-industrial environments.

This product meets the requirements of the standard EN 61000-6-3:2007 Generic standards - Emission standard for residential, commercial and light-industrial environments.

Identification for Eurasian Customs Union



- EAC (Eurasian Conformity)
- Customs union of Russia, Belarus and Kazakhstan
- Declaration of conformity according to Technical Regulations of the Customs Union (TR CU)

KOREA



This product meets the requirements of Korean certification.

This product satisfies the requirement of the Korean Certification (KC Mark).

이 기기는 업무용(A급) 전자파 적합기기로서 판매자 또는 사용자는 이 점을 주의하시기 바라며 가정 외의 지역에서 사용하는 것을 목적으로 합니다.

8.2 Directives and declarations

8.2.1 CE marking



The device meets the guidelines listed in the following sections.

EC Declaration of Conformity

The associated declaration of conformity is available on the Internet at the following address: SIEMENS Industry Online Support (<http://support.automation.siemens.com/WW/view/en/10805661/130000>).

Electromagnetic compatibility

This product meets the requirements of EU Directive 2014/30/EU "Electromagnetic Compatibility".

The device is designed for the following areas of application corresponding to the CE marking:

Scope of application	Requirements for	
	Interference emission	Immunity to interference
Industrial area	EN 61000-6-4 : 2007 +A1:2011	EN 61000-6-2 : 2005
Residential and commercial areas and small businesses	EN 61000-6-3 : 2007 +A1:2011	EN 61000-6-1 : 2007

The devices conform with EN 61000-3-2:2014 (harmonics) and EN 61000-3-3:2013 (voltage fluctuations and flicker).

Low-voltage directive

The device with AC power supply complies with the requirements of the EU Directive 2014/35/EU "Low Voltage Directive". Compliance with this standard has been verified according to 60950-1:2006 +A11:2009 +A1:2010 +A12:2011 +A2:2013.

8.2.2 ESD guideline

What does ESD mean?

An electronic module is equipped with highly integrated components. Due to their design, electronic components are highly sensitive to overvoltage and thus to the discharge of static electricity. Such electronic components or modules are labeled as electrostatic sensitive devices.

The following abbreviations are commonly used for electrostatic sensitive devices:

- ESD – Electrostatic sensitive device
- ESD – Electrostatic Sensitive Device as a common international designation

Electrostatic sensitive devices can be labeled with an appropriate symbol.



NOTICE

Damage to ESD from touch

Electrostatic sensitive devices, ESD, can be destroyed by voltages which are far below the human perception limit. If you touch a component or electrical connections of a module without discharging any electrostatic energy, these voltages may arise.

The damage to a module by an overvoltage can often not be immediately detected and only becomes evident after an extended period of operation. The consequences are incalculable and range from unforeseeable malfunctions to a total failure of the machine or system.

Avoid touching components directly. Make sure that persons, the workstation and the packaging are properly grounded.

Charge

Every person without a conductive connection to the electrical potential of his/her surroundings can be electrostatically charged.

The material with which this person comes into contact is of particular significance. The figure shows the maximum electrostatic voltages with which a person is charged, depending on humidity and material. These values conform to the specifications of IEC 61000-4-2.

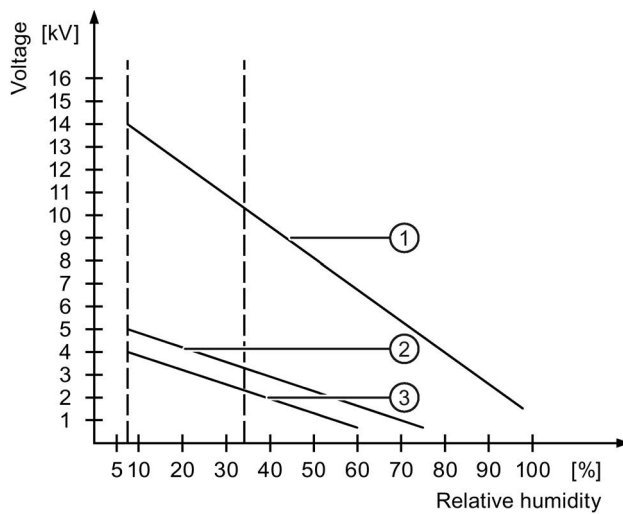

- ① Synthetic materials
- ② Wool
- ③ Antistatic materials such as wood or concrete

NOTICE

Grounding measures

There is no equipotential bonding without grounding. An electrostatic charge is not discharged and may damage the ESD.

Protect yourself against discharge of static electricity. When working with electrostatic sensitive devices, make sure that the person and the workplace are properly grounded.

Protective measures against discharge of static electricity

- Disconnect the power supply before you install or remove modules which are sensitive to ESD.
- Pay attention to good grounding:
 - When handling electrostatic sensitive devices, make sure that persons, the workstation and devices, tools and packaging used are properly grounded. This way you avoid static discharge.
- Avoid direct contact:
 - As a general rule, do not touch electrostatic sensitive devices, except in the case of unavoidable maintenance work.
 - Hold the modules at their edge so that you do not touch the connector pins or conductor paths. This way, the discharge energy does not reach and damage the sensitive components.
 - Discharge your body electrostatically before you take a measurement at a module. Do so by touching grounded metallic parts. Always use grounded measuring instruments.

8.3 Dimension drawings

8.3.1 Dimension drawing of the device

Device with standard enclosure: Front view and top view

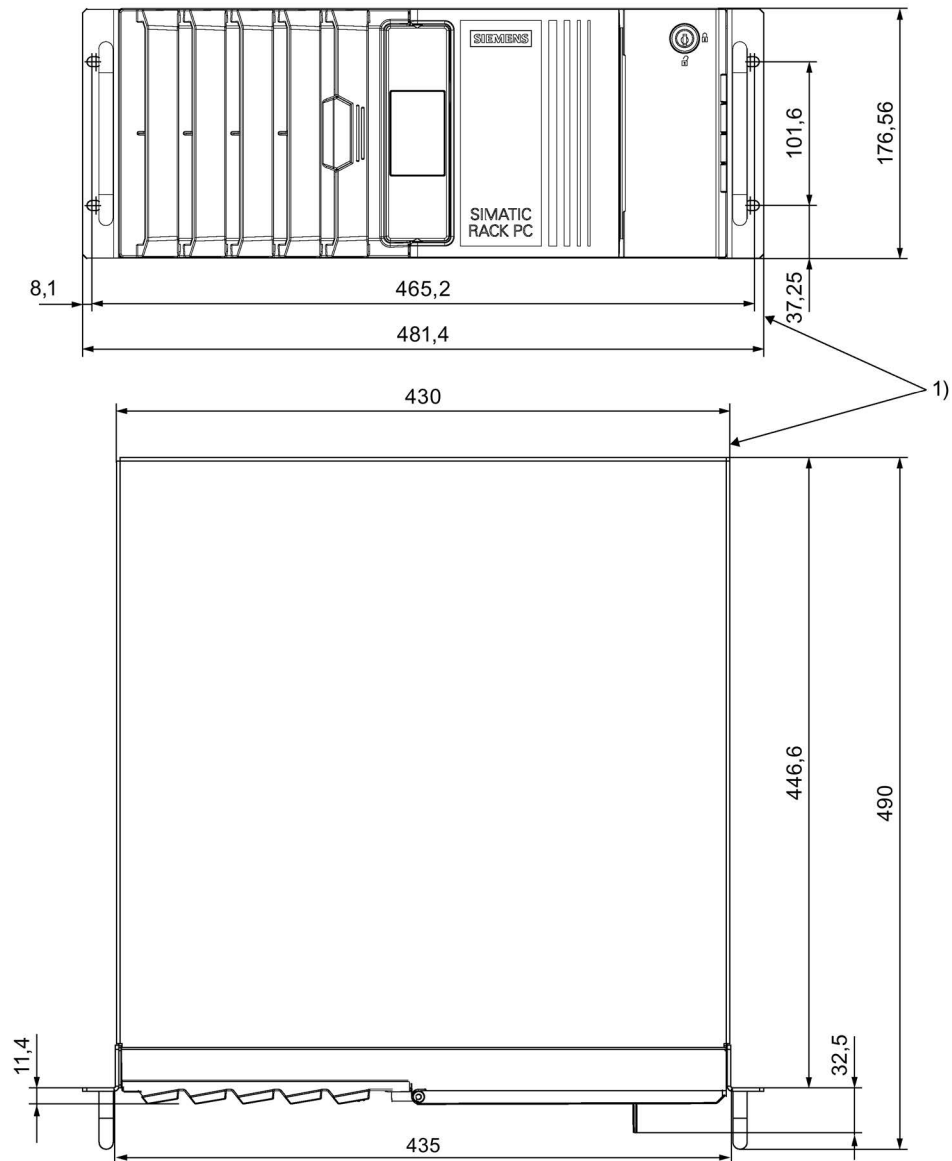

1) At top when installed vertically. All dimensions in mm.

8.3.2 Dimension drawing of the expansion cards

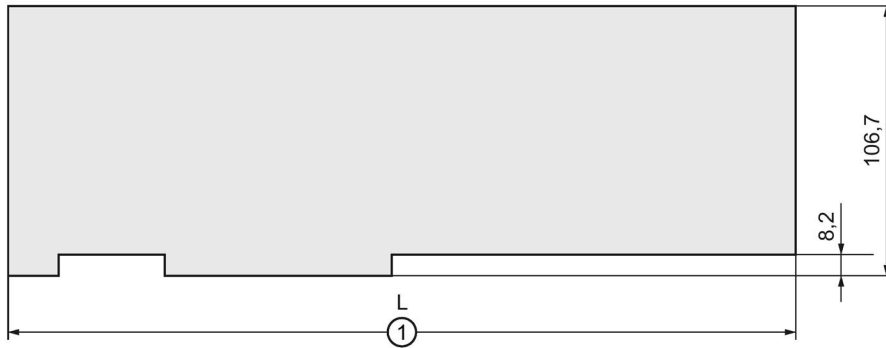

- ① L Length of expansion card
Device with standard enclosure: 312
- All dimensions in mm

8.3.3 Dimension drawing of the telescope rails

Device with standard enclosure: Dimensions for bore holes for telescopic rails

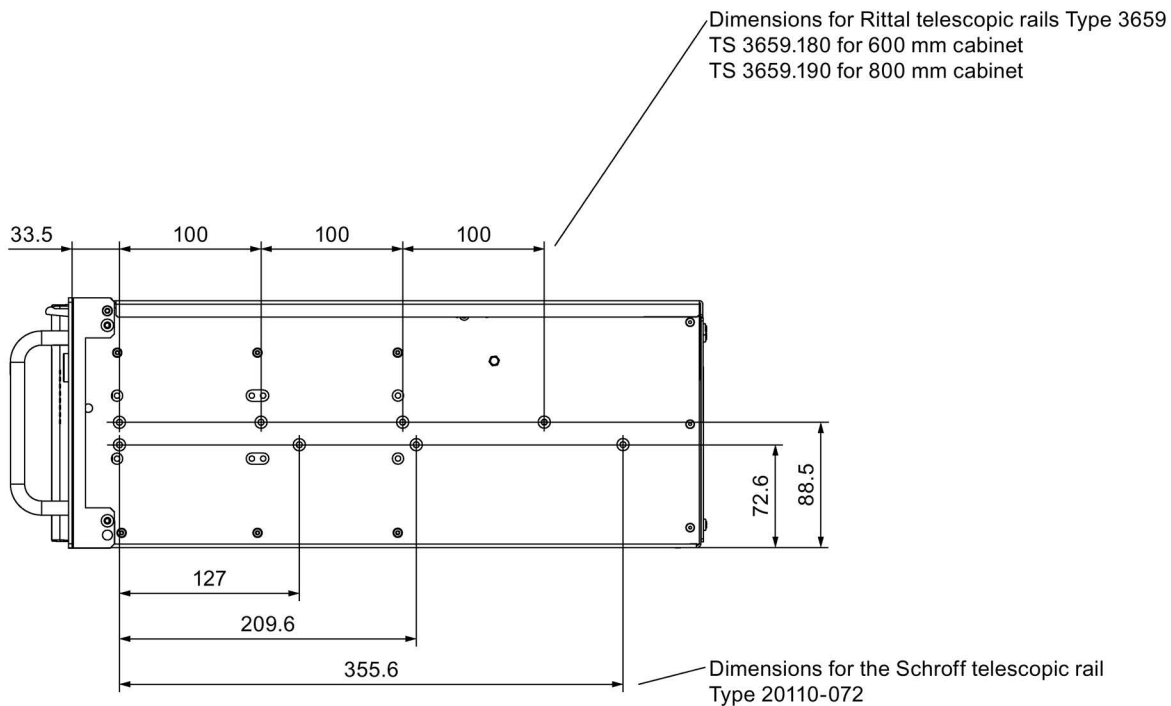

All dimensions in mm.

8.4 Technical specifications

8.4.1 General technical specifications

Note

Applicability of technical specifications

The following technical specifications only apply under the following conditions:

- The device is in good working order.
- The fan cover and filter pad are installed.
- The device is closed.

Order numbers	6AG4104-4....-.... (for details, refer to the ordering documentation)
Dimensions	433.5 x 176.5 x 445.5 (W x H x D in mm)
	Detailed information on the dimensions can be found in the chapter "Dimension drawing of the device (Page 129)".
Weight	15 up to 23 kg; depending on the equipment
Supply voltage (V _N)	Power supply: 100 V AC to 240 V AC (-15%; +10%)
	Redundant power supply: 2 x 100 V AC to 240 V AC (-15%; +10%)
Input current	Power supply: <ul style="list-style-type: none"> • Continuous current at 100 V: ≤ 6 A • Continuous current at 240 V: ≤ 3 A • at startup ≤ 80 A for 3.6 ms
	Redundant power supply: <ul style="list-style-type: none"> • Continuous current at 100 V: ≤ 5 A • Continuous current at 240 V: ≤ 2.5 A • at startup ≤ 210 A for 1.65 ms for each module
Frequency	50 to 60 Hz, min. 47 Hz to max. 63 Hz, sinusoidal
Transient voltage interruption	Power supply: <ul style="list-style-type: none"> • 20 ms for 230 W • ≤ 10 events/h; recovery time ≥ 1 s
	Redundant power supply: <ul style="list-style-type: none"> • 20 ms for 240 W • ≤ 10 events/h; recovery time ≥ 1 s
Power consumption with maximum configuration and 230 W secondary	Power supply ≤ 260 W with 90% efficiency
	Redundant power supply ≤ 270 W with 85% efficiency
Power loss, heat emission	Power supply: 260 W = 260 J/s = 0.25 BTU/s
	Redundant power supply: 270 W = 270 J/s = 0.26 BTU/s

8.4 Technical specifications

Current delivery (DC)	Power supply:
	<ul style="list-style-type: none"> • +5 V/25 A, +3.3 V/20 A <p>190 W permitted in total</p> <ul style="list-style-type: none"> • +12 V₁/14 A, +12 V₂/11 A • -12 V/0.1 A, +5 V_{aux}; 2 A
	<p>Redundant power supply:</p> <ul style="list-style-type: none"> • +5 V/20 A, +3.3 V/20 A <p>100 W permitted in total</p> <ul style="list-style-type: none"> • +12 V₁/16 A, +12 V₂/16 A • -12 V/0.5 A, +5 V_{aux}; 3 A
The total sum of all voltages is max. 230 W.	
Noise emission	< 45 dB (A) to DIN 45635 At 20 °C and in Windows idle mode the result is 40 dB (A).
Degree of protection	<ul style="list-style-type: none"> • IP 30 (front) with closed front door • IP 20 on the rear according to EN 60529
Dust protection	With closed front door Filter class G2 EN 779; particles > 0.5 mm are 99% retained
Safety	
Protection class	Protection class I compliant with IEC 61140
Safety regulations	<ul style="list-style-type: none"> • IEC 60950-1 • EN 60950-1 • UL 60950-1 • CSA C22.2 No 60950-1-07

Electromagnetic compatibility

Emitted interference (AC)	EN 61000-6-3; EN 61000-6-4; CISPR 22, EN 55022 Class B; FCC Class A / EN 61000-3-2 Class D; EN 61000-3-3
Noise immunity: interference conducted on the power supply lines	± 2 kV; according to IEC 61000-4-4; burst ± 1 kV; according to IEC 61000-4-5; surge symm ± 2 kV; according to IEC 61000-4-5; surge symm
Noise immunity on signal lines	± 2 kV; according to IEC 61000-4-4; burst; length > 30 m ± 1 kV; according to IEC 61000-4-4; burst; length < 30 m ± 2 kV; according to IEC 61000-4-5; burst; length > 30 m
Immunity to discharges of static electricity	± 4 kV contact discharge (according to IEC 61000-4-2) ± 8 kV air discharge; (according to IEC 61000-4-2)
Immunity to RF interference	<ul style="list-style-type: none"> • 10 V/m; 80 up to 1000 MHz, 80% AM to IEC 61000-4-3 • 3 V/m; 1.4 to 2 GHz, 80% AM to IEC 61000-4-3 • 1 V/m; 2 up to 2.7 GHz, 80% AM to IEC 61000-4-3 • 10 V; 150 kHz up to 80 MHz, 80% AM to IEC 61000-4-6
Magnetic field	30 A/m; 50 Hz; 60 Hz (according to IEC 61000-4-8)

Ambient conditions

Climatic ambient conditions	
Temperature	Tested according to IEC 60068-2-2; IEC 60068-2-1; IEC 60068-2-14
Operation	+0 °C up to +40 °C ¹ Gradient: ≤ 10 K/h; no condensation
Storage/transportation	-20 °C up to +60 °C Gradient: ≤ 20 K/h; no condensation
Relative humidity	Tested according to IEC 60068-2-78; IEC 60068-2-30
Operation	5% up to 85% at 30 °C; no condensation Gradient: ≤ 10 K/h; no condensation
Storage/transportation	5% up to 95% at 25 °C to 55 °C; no condensation Gradient: ≤ 20 K/h; no condensation
Atmospheric pressure	
Operation	1080 up to 689 hPa, corresponds to an altitude of -1000 m to 3000 m
Storage/transportation	1080 up to 660 hPa, Corresponds to an altitude of -1000 m to 3500 m
Mechanical ambient conditions	
Vibration	Tested according to IEC 60068-2-6; 10 cycles
Operation ²	20 to 58 Hz, Amplitude 0.015mm; 58 to 200 Hz: 2 m/s ²
Storage/transport	5 up to 8.51 Hz; amplitude 3.5 mm; 8.51 up to 500 Hz: 9.8 m/s ²
Resistance to shock	Tested in accordance with IEC 60068-2-27
Operation ²	Half-sine; 9.8 m/s ² , 20 ms; 100 shocks per axis
Storage/transportation	Half-sine; 250 m/s ² ; 6 ms; 1000 shocks per axis
Special features	
Quality assurance	In accordance with ISO 9001

¹ No burner operation.

At +5 °C up to +35 °C, without limitation; for information on higher ambient temperature, see section "Information on expansions (Page 61)".

² The device must be free of any mechanical faults when installing hard disk drives in the removable tray. No mechanical interferences due to vibrations may be present when using DVD burner drives.

Drives

Information on the drives is available in your order documents.

SATA drive	<p>Maximum number: 6 (depends on the selected configuration)</p> <p>HDD types (Native Command Queuing is supported):</p> <ul style="list-style-type: none"> • 3.5" SATA, 6 GB/s; 1000 GB • 3.5" SATA, Enterprise, 6 GB/s; 2000 GB <p>SSD types (flash memory):</p> <ul style="list-style-type: none"> • 2.5" SATA, 6 GB/s; 240 GB • 2.5" SATA, 6 GB/s; 480 GB
DVD burner ¹	<p>Slimline SATA</p> <p>Read:</p> <ul style="list-style-type: none"> • DVD ROM, Single Layer and Dual Layer: 8 × • DVD+R/RW, DVD-R/RW, DVD-RAM: 8 × • CD-ROM, CD-R, CD-RW: 24 × <p>Write:</p> <ul style="list-style-type: none"> • DVD-R: 8 × • DVD-R DL: 6 × • DVD-RW: 6 × • DVD+R: 8 × • DVD+R DL: 6 × • DVD+RW: 8 × • DVD-RAM: 5 × • CD-R: 10 × • CD-RW: 16 ×

¹ No mechanical interferences may be present during the burning process when using a DVD burner drive.

Motherboard

	Device with motherboard D3446	Device with motherboard D3445
Chipset	Intel® GL82C236 PCH	Intel® GL82 H110 PCH
Processor	<ul style="list-style-type: none"> • Intel® Pentium® Processor G4400 2C/2T, 3.3 GHz; 3 MB cache • Intel® Core™ i5-6500 4C/4T, 3.2 (3.6) GHz; 6 MB cache; iAMT • Intel® Core™ i7-6700 4C/8T, 3.4 (4.0) GHz, 8 MB cache, iAMT • Intel® Xeon® Processor E3-1275 v5 4C/8T, 3.6 (4.0) GHz, 8 MB cache, iAMT 	<ul style="list-style-type: none"> • Intel® Pentium® Processor G4400 2C/2T, 3.3 GHz; 3 MB cache • Intel® Core™ i5-6500 4C/4T, 3.2 (3.6) GHz; 6 MB cache; iAMT • Intel® Core™ i7-6700 4C/8T, 3.4 (4.0) GHz, 8 MB cache, iAMT
RAID (on-board)	Intel® PCH with Intel® Rapid Storage Technology	-
Slots for memory modules	4 x DIMM slots for DDR4 2133, expandable to 64 GB	2 x DIMM slots for DDR4 2133, expandable to 32 GB
Main memory	4 up to 64 GB, DDR4 SDRAM PC4-2400T	4 up to 32 GB, DDR4 SDRAM PC4-2400T
	Max. of 3.2 GB can be used for 32-bit versions of operating system and applications; see order documents for equipment	
Expansion card slots	* open direct plug sockets <ul style="list-style-type: none"> • 2 x PCI • 1 x PCIe x4* (4 lanes); Gen 3.0 • 1 x PCIe x4* (1 lane); Gen 3.0 • 1 x PCIe x16 (4 lanes); Gen 3.0 • 1 x PCIe x8* (1 lane); Gen 3.0 • 1 x PCIe x16; Gen 3.0 	* open direct plug sockets <ul style="list-style-type: none"> • 2 x PCI • 2 x PCIe x4* (1 lane); Gen 2.0 • 1 x PCIe x16 (1 lane); Gen 2.0 • 1 x PCIe x8* (1 lane); Gen 2.0 • 1 x PCIe x16; Gen 3.0
Power consumption per PCI slot, maximum permitted	<ul style="list-style-type: none"> • 5 V; 5 A or 3.3 V; 7 A • 12 V; 0.5 A • 12 V; 0.05 A • 3.3 V_{aux}; 0.4 A 	
Power consumption per PCIe slot with x4 expansion card, maximum permitted	<ul style="list-style-type: none"> • 3.3 V; 3 A • 12 V; 2.1 A • 3.3 V_{aux}; 0.4 A 	
Power consumption per PCIe slot with x16 expansion card, maximum permitted	<ul style="list-style-type: none"> • 3.3 V; 3 A • 12 V; 2.1 A • 3.3 V_{aux}; 0.4 A 	
Power consumption per slot, permitted	≤ 25 W	
Power loss all slots, permitted	≤ 80 W In sum, the current for 3.3 V _{aux} may not exceed 1.2 A.	

Graphics

	Device with motherboard D3446	Device with motherboard D3445
Graphic controller	<ul style="list-style-type: none"> Intel® HD Graphics 510 integrated in processor: Intel® Pentium® Processor G4400 Intel® HD Graphics 530 integrated in processor: Intel® Core™ i5-6500 Intel® Core™ i7-6700 Intel® HD Graphics P530 integrated in processor: Intel® Xeon® Processor E3-1275 v5 	<ul style="list-style-type: none"> Intel® HD Graphics 510 integrated in processor: Intel® Pentium® Processor G4400 Intel® HD Graphics 530 integrated in processor: Intel® Core™ i5-6500 Intel® Core™ i7-6700
Graphics memory	Dynamic Video Memory Technology, occupies 32 MB to 1.7 GB of main memory	
Resolutions/frequencies/colors	<ul style="list-style-type: none"> DVI up to 1920 × 1200 pixels at 60 Hz; color depth up to 32-bit/pixel DisplayPort up to 4096 × 2304 pixels at 60 Hz; color depth up to 32-bit/pixel VGA (VGA via DP-VGA adapter) up to 2560 × 1600 pixels at 60 Hz; color depth up to 32-bit/pixel 	
Graphics card (optional)	PCIe x16; Dual Head; 2 × DisplayPort or 2 × VGA or 2 × DVI-D ¹ <ul style="list-style-type: none"> Type: NVIDIA NVS315, 1 GB graphics memory Maximum resolution: <ul style="list-style-type: none"> DisplayPort 2560 × 1600 at 60 Hz; 32-bit color depth DVI 1920 × 1200 at 60 Hz; 32-bit color depth VGA 2048 × 1536 at 60 Hz; 32-bit color depth 	

¹ Adapter for VGA and DVI-D supplied

Interfaces

	Device with motherboard D3446	Device with motherboard D3445
COM 1	Serial interface 1 (V.24), 9-pin D-sub socket	-
COM 2 (optional)	Serial interface 2 (V.24), 9-pole sub D socket	
LPT (optional)	Port for printer with parallel interface. The parallel interface supports the following modes: <ul style="list-style-type: none"> STD Printer Mod SPP Mode EPP-1.9 and SPP Mode EPP-1.7 and SPP Mode 	
DisplayPort V1.2 ¹	2 x connection of a digital monitor	1 x connection of a digital monitor
DVI-D	For connecting a digital monitor	
2 × DVI-I/DPP with dual-head graphics card (optional)	For connecting two digital or analog monitors using adapter cable for DPP, DVI-D and VGA	

	Device with motherboard D3446	Device with motherboard D3445
PS/2 keyboard	1 × keyboard port	
PS/2 mouse	1 × mouse port	
USB 2.0	USB 2.0 HighSpeed <ul style="list-style-type: none"> • Back of device: 4 × 500 mA / high current • Internal: 1 × 500 mA / high current with optional mechanical lock 	USB 2.0 HighSpeed <ul style="list-style-type: none"> • Back of device: 4 × 500 mA / high current
USB 3.0	USB 3.0 SuperSpeed backward compatible with USB 2.0/1.1 <ul style="list-style-type: none"> • Back of device: 4 × 900 mA / high current² • Front of device: 2 × 900 mA / high current² 	USB 3.0 SuperSpeed backward compatible with USB 2.0/1.1 <ul style="list-style-type: none"> • Back of device: 2 × 900 mA / high current³ • Front of device: 2 × 900 mA / high current³
Ethernet	2 × Ethernet interface (RJ45), 10/100/1000 Mbps	
	Ethernet 1: Intel® Jacksonville i219-LM	
	• AMT-capable ⁴	• Not AMT-capable
	Ethernet 2: Intel® Springville i210-AT	
	Wake on LAN, Remote Boot and the Teaming modes are supported: <ul style="list-style-type: none"> • Adapter Fault Tolerance (AFT) • Adaptive Load Balancing (ALB) • IEEE 802.3ad Dynamic Link Aggregation (DLA) • Static Link Aggregation (SLA) • Switch Fault Tolerance (SFT) 	
Audio	Realtek ALC671, 6-channel DAC support <ul style="list-style-type: none"> • Micro • Line In • Line out: 2 W at 4 Ω 	

¹ An analog monitor can be used with an adapter cable (optional).

² in total ≤ 3 A

³ in total ≤ 2 A

⁴ AMT and teaming cannot be used simultaneously on the Ethernet interface teaming is not possible in connection with Windows 10.

8.4.2 Current and power requirements

Base system

Component	Voltage					
	+3.3 V	+5 V	+12 V	+12 V2	-12 V	5 Vaux
Motherboard core i processor with cooling	0.43 A	2.6 A	0.72 A	6.7 A	0 A	0.28 A
Front fan			0.5 A			
Hard disk drive ¹ SATA (typical values)		0.6 A	0.3 A			
Base system (Core i) ¹	0.43 A	3.2 A	1.52 A	6.7 A	0 A	0.28 A
Motherboard Pentium processor with cooling	0.43 A	2.6 A	0.72 A	5.6 A	0 A	0.28 A
Motherboard Xeon processor with cooling ¹	0.43 A	2.6 A	0.72 A	8.3 A	0 A	0.28 A
SSD SATA (typical)		0.8 A				
Hard disk drive ¹ SATA type Enterprise (typical values)		0.5 A	0.7 A			
Internal fan			0.25 A			
DVD burner drive, Slimline (typical) ¹		0.8 A				
Dual-head graphics	3.3 A		1.1 A			
Single currents ATX, max. permitted	20 A ²	25 A ²	14 A	11 A	0.1 A	2.0 A ³
Single currents ATX redundant, max. permitted	20 A ²	20 A ²	16 A	16 A	0.5 A	3.0 A ³
Total power consumption, permissible	230 W					
Efficiency of the simple power supply ¹	Approx. 90% (230 V AC) / approx. 90% (120 V AC)					
Efficiency of the redundant power supply ¹	Approx. 85% (230 V AC) / approx. 85% (120 V AC)					

¹ Depends on the selected device configuration

² The accumulated power of the +5 V and + 3.3 V with ATX power supply may not exceed 190 W, with ATX redundant not to exceed 100 W.

³ 2.5 A for 10 seconds

Typical power values

Component	Current consumption (AC-SV, U=230 V)	Power consumption
Base device Pentium	0.39 A	89 W
Base device Pentium SATA Enterprise	0.43 A	97 W
Base device Core i	0.46 A	103 W
Base device Core i SATA Enterprise	0.48 A	109 W
Base device Xeon	0.53 A	120 W
Base device Xeon SATA Enterprise	0.56 A	126 W
1 × hard disk drive SATA	0.03 A	7.3 W
2 × hard disk drives SATA	0.07 A	14.7 W
3 × hard disk drives SATA	0.1 A	22.0 W
1 × hard disk drives SATA type Enterprise	0.05 A	12.1 W
2 × hard disk drives SATA type Enterprise	0.11 A	24.2 W
3 × hard disk drives SATA type Enterprise	0.16 A	36.3 W
1 × SSD 2.5" drive SATA	0.02 A	3.6 W
DVD burner drive, Slimline	0.01 A	2.2 W
Dual-head graphics card	0.1 A	21.4 A

8.4.3 AC power supply

Voltage	Maximum current	Voltage stability
+12 V	10 A	± 5%
+12 V	13 A	± 5%
-12 V	0.3 A	± 10%
+5 V	25 A ¹	± 5%
+3.3 V	20 A ¹	± 5%
+5 V _{aux}	2.5 A	+5%, -3%

¹ The total output of the +5 V and +3.3 V voltage must be ≤ 190 W.

The inrush current is:

- ≤ 80 A for 3.6 ms

8.4.4 AC power supply, redundant

Voltage	Max. current	Voltage stability
+12 V	16 A ²	± 5%
+12 V	16 A ²	± 5%
-12 V	0.5 A	± 10%
+5 V	20 A ¹	± 5%
+3.3 V	20 A ¹	± 5%
+5 V aux	3.0 A	+5%, -3%

¹ The total output of the +5 V and +3.3 V voltage must be ≤ 100 W.

² The total current of the +12 V voltage must be ≤ 25 A.

The inrush current of a plug-in module is:

- ≤ 210 A for 1.65 ms

8.4.5 Technical specifications of the telescopic rails

Ultimate load per pair	≥ 30 kg
Full extraction length	≥ 470 mm
Rail thickness	≤ 9.7 mm
Mounting screws	M5 x 6 mm The mounting screws of the telescopic rails may not protrude by more than 5 mm into the enclosure.

See also

Dimension drawing of the telescope rails (Page 130)

8.5 Hardware description

8.5.1 Motherboard

A detailed description of the motherboard and the ports is available in the manual for the motherboard on the supplied "Documentation and Drivers" DVD.

8.5.2 System resources

All system resources (hardware addresses, memory configuration, allocation of interrupts, DMA channels) are assigned dynamically by the Windows OS, depending on the hardware configuration, drivers and connected external devices. You can view the current configuration of system resources or possible conflicts with the following operating systems:

Microsoft Windows	<ol style="list-style-type: none">1. Press the "Windows key" and "R" at the same time. The "Run" dialog box opens.2. Enter "msinfo32" in the "Open" field.3. Confirm your entry with "OK".
-------------------	--

8.5.3 Interrupt assignment

Interrupt assignment depending on operating system

The functions are assigned different interrupts (IRQ), depending on the operating system. A distinction is made between the PIC and APIC modes.

Function	IRQ Number																								Comment
	0	1	2	3	4	5	6	7	8	9	10	11	12	13	14	15	16	17	18	19	20	21	22	23	
IRQ (APIC-Mode)	0	1	2	3	4	5	6	7	8	9	10	11	12	13	14	15	16	17	18	19	20	21	22	23	
IRQ (PIC-Mode)	0	1	2	3	4	5	6	7	8	9	10	11	12	13	14	15	16	17	18	19	20	21	22	23	
Host PCI IRQ Line																	A	B	C	D	E	F	G	H	1)
Function																									
Timer 0	X																								Fixed
PS/2 Keyboard		X																							Fixed
Serial Port 2			X																						Can be disabled
Serial Port 1				X																					Can be disabled
Parallel Port					X																				Can be disabled
real time clock RTC								Z																	
PS/2 Mouse												X													Fixed
Numeric Processor													X												Fixed
SATA AHCI																	Y								Fixed
SMBus																	Y								Fixed
Ethernet 1 (LAN i219-LM)																	Y								Can be disabled
Ethernet 2 (LAN i210)																		Y							Can be disabled
HD Audio																	Y								Can be disabled
CPU int. Grafic																	Y								Fixed
USB3 xHCI																	Y								Can be disabled
PCH ME #1																	Y								Can be disabled
PCH-PCIe-Bridge																	Y								Fixed
PCH-PCI-Bridge																Z	Z								
																	Z								

1) Host PCI-IRQ A to H is assigned to IRQ 16 to 23 permanently in APIC mode. Host PCI-IRQ A to H is assigned to IRQ 0 to 15 automatically by the BIOS in PIC mode. A specific assignment cannot be forced.

X Interrupt PIC and APIC mode

Y Interrupt APIC mode

Z BIOS Default Interrupt PIC mode, e.g. DOS

Slot-specific interrupt assignment

Interrupt routing of the slot connectors on the motherboard.

Interrupt assignment of the slot connectors

Note

All system resources (hardware addresses, memory utilization, interrupt assignment, DMA channels) are assigned dynamically by the BIOS or the Windows operating system, depending on the hardware equipment, drivers, inserted expansion cards and connected external devices.

Assignment is automatic and depends on the demanded resources of the connected devices and the inserted expansion cards. Due to this configuration dependency, clear statements can only be made by determining them with the system in the final configuration. The following tables are an example of the assignment if the device is operated in PIC mode (legacy boot media).

Slot	Type	IRQ-PIC mode
1	PCIe CPU *	11
2	PCIe PCH *	11
3	PCIe PCH *	11
4	PCIe PCH *	11
5	PCIe PCH *	11
6	PCI 1	11
7	PCI 2	11

* For version of direct plug connector socket and number of active PCIe lanes of the slot, see "Motherboard" in the "Technical specifications" section

The table applies to the configuration with an expansion card which uses only an interrupt, e.g. PCI expansion cards which use the interrupt INTA#, connected to pin A6 of PCI bus connector.

Exclusive PCI hardware interrupt

Applications demanding a high-performance interrupt require a high-speed hardware interrupt reaction. The PCI hardware interrupt should be used only by one resource in order to ensure high-speed reaction of the hardware.

Setting up an exclusive interrupt on the device (APIC mode only)

An exclusive interrupt can be used for PCI 1 slot 6 IRQ (APIC mode) 31 and PCI 2 slot 7 IRQ (APIC mode) 48. Further exclusive interrupts for use at the slots are not available.

Assigning exclusive interrupts in BIOS Setup (PIC mode only)

The interrupts are automatically assigned to the slots at system startup due to the default settings in system BIOS. Several slots may share the same interrupt, depending on the system configuration. This functionality is known as interrupt sharing.

Exclusive interrupts are not available in PIC mode. Disable specific system resources in order to obtain exclusive interrupts. BIOS assigns the PIC interrupts at random during restart of the system.

8.6 BIOS description

You can set the system functions and the hardware configuration of the device in the BIOS Setup.

Prior to delivery, the BIOS Setup has the default settings that are suitable for the device configuration. The most important default settings are shown in the table below.

Tab	Option	Setting
Advanced	Drive Configuration > SATA Mode	AHCI or RAID ¹
	Drive Configuration > SATA Port 0: Hot Plug ²	Disabled, Enabled ³
	Drive Configuration > SATA Port 1: Hot Plug ²	Disabled, Enabled ³
	Drive Configuration > SATA Port 2: Hot Plug ²	Disabled, Enabled ^{3 4}
	Drive Configuration > SATA Port 3: Hot Plug ²	Disabled, Enabled ^{3 4}
	Drive Configuration > SATA Port 4: Hot Plug ²	Disabled, Enabled ^{3 4}
	CSM Configuration > Launch PXE OpROM Policy	Do not launch
	System Monitoring > Fan Control	Enhanced
	AMT Configuration > USB Provisioning of AMT ⁵	Disable
Power	Power Failure Recovery	Previous State
	Low Power Soft Off	Disable
	Hibernate like Soft Off	Disable
Boot	Quiet Boot	Disable

¹ RAID optional for devices with motherboard D3446.

² Parameter "Hot Plug" is only available if "External SATA" is enabled (Enabled).

Note: After you have set the parameter "Hot Plug", you have to disable "External SATA" again (Disabled).

³ Optional for devices with a removable tray.

⁴ For devices with motherboard D3446.

⁵ For devices with motherboard D3446, dependent on the processor equipment.

For a detailed description of how to call up and operate the BIOS setup and which menus and setting options are available, refer to the BIOS reference manual on the "Documentation and Drivers" DVD that ships with the manual.

Note

After a BIOS update, you need to execute the "Restore Defaults" command. Executing the "Restore Defaults" command restores all BIOS settings to their original state.

Power failure recovery

The following two settings are possible in the "Power Failure Recovery" BIOS setup entry:

- The device switches on automatically.
The device switches on automatically when the device was separated from the mains supply for at least 20 s. This setting is of importance even if the device is always switched off with a hardware reset. The device always starts automatically when the power supply is re-connected at a later time.
- The on/off/ button must be operated.
The device does not switch on automatically.

Note

Automatic startup may endanger the operation of the machine or plant, for example, after a power failure. Take this into account when designing the plant.

8.7 Active Management Technology (AMT)

8.7.1 AMT basics

The processors Intel® Core™ i5, Core™ i7 and Intel® Xeon® support Intel Active Management Technology at the hardware end. The processor Intel Xeon E3 supports Intel® vPro™. An administrator at the Help Desk PC accesses the AMT PCs. Only the AMT PCs must have an integrated Intel AMT.

The following figure shows the possible structure of a network for remote management on the basis of SIMATIC AMT-PCs.

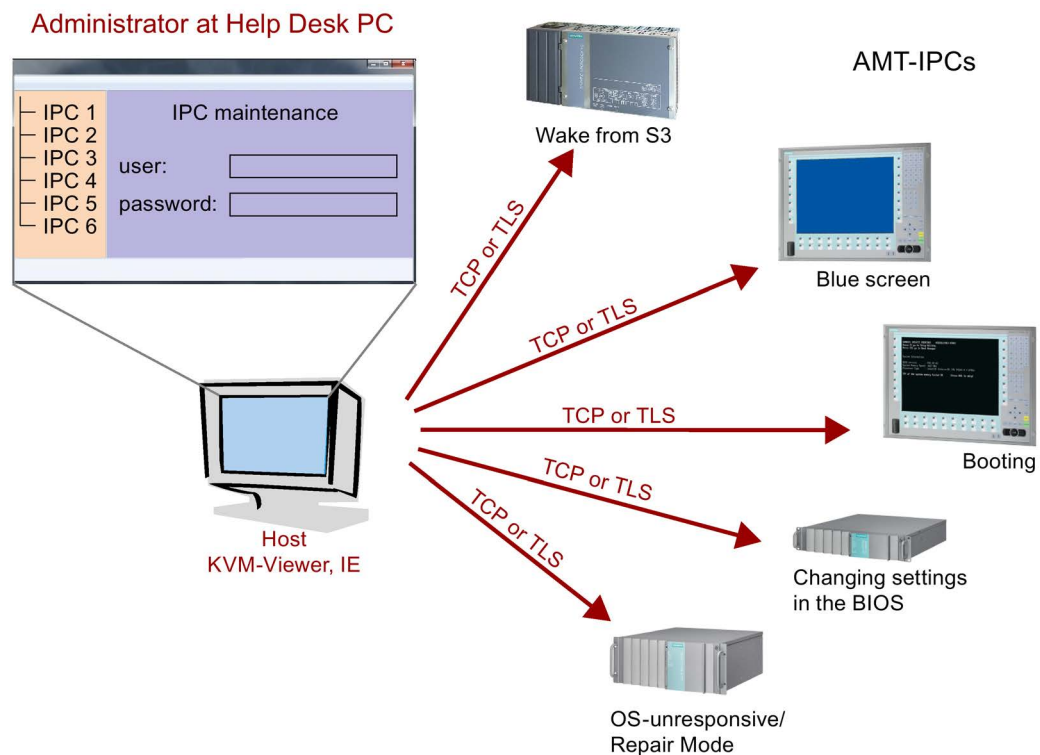

From a SIMATIC IPC which does not have Intel AMT functions, you can access networked SIMATIC IPCs with Intel AMT using the SIMATIC IPC Remote Manager and/or a web browser.

A SIMATIC IPC that supports AMT features two onboard Ethernet interfaces, each with a separate controller. You can configure the controller integrated in the chipset for use with Intel AMT. Further details about the controller can be found in the technical specification.

For security reasons, AMT is disabled when you receive the SIMATIC IPC. Enable AMT in the BIOS setup. Afterwards the Intel® Management Engine (Intel® ME) has to be activated and set for AMT. Set the following in the Management Engine:

- Configure network for access via AMT
- Create password

8.7.2 Overview of AMT

This section describes the required measures and settings on the local IPC so that the IPC can be controlled and maintained remotely from a management station known below as the help desk PC.

The local IPC is known below as the "AMT PC".

The sections contain the following information:

- AMT settings in the MEBx and in the BIOS setup
- Basic configuration of AMT
- Further useful notes

8.7.3 Activate AMT

For security reasons, AMT is not enabled on new devices.

Procedure

1. Connect the AMT PC by means of "Create Internet connection" when using the corresponding LAN controller (LAN 1).

2. If necessary, first reset AMT to the default status.

You can find the required information in the section "Reset AMT with Unconfigure ME (Page 149)".

3. To access the BIOS, press the <F2> key while the device is booting.

4. Select the "Intel AMT" parameter in the "Advanced > AMT Configuration" menu.

5. Exit BIOS with the key <F4> "Save & Exit".

The AMT PC starts.

6. To access the MEBx, press the <Ctrl+P> keyboard shortcut at system power-up.

7. In the login dialog, enter the standard password "admin".

8. Change the default password.

The new password must include the following characters:

- In total at least eight characters
- One upper case letter
- One lower case letter
- One number
- A special character . ! @ # \$ % ^ & *

Note

The underscore and blank space are valid password characters but do not increase password complexity.

9. Enable "Intel (R) AMT Configuration > Manageability Feature Selection".

10. Enable "Intel (R) AMT Configuration > Activate Network Access".

8.7.4 Advanced settings

The BIOS and the MEBx contain the most important basic settings for AMT. Additional tools are necessary if you want to make more advanced settings. If required, these must be downloaded from the relevant manufacturer's site. For information on the options and use of these tools, refer to the relevant documentation of the manufacturer.

- Manageability Commander and other tools of the Intel DTK (Manageability Developer Tool Kit): Programs from the Intel DTK that you can download from the Internet at "<http://software.intel.com/en-us/manageability>".
- AMT Web interface: The URL of the Web interface is "<http://<IP Address>:16993>" for encrypted connections and "<http://<IP address>:16992>" for unencrypted connections.
- WinRM: A command line program that is part of Windows as of Windows Vista. This tool can be downloaded for older Windows versions.

8.7.5 Reset AMT with Unconfigure ME

Note

If the factory setting for the AMT PC was not changed, you can skip this chapter.

If you have already configured AMT previously, discard all previous AMT settings made in the MEBx.

Note

Note the following points:

- All previous settings in the Management Engine are deleted.
 - Correct operation in the plant may be at risk.
 - Note down all the settings in the MEBx. Make the settings again as necessary following Unconfigure.
-

The device continues booting in factory setting.

Procedure

1. Select the "Un-Configure AMT/ME" parameter in the "Advanced > AMT Configuration" menu.
2. Exit BIOS with the key <F4>. Your entry is saved and BIOS is closed. The AMT PC starts.
3. After the start, a user prompt appears asking whether you really want to discard all the settings in the Management Engine.
4. Confirm with "Y". On a German keyboard, this means pressing the <Z> key.

8.7.6 Determining the network address

To connect the AMT PC with the AMT server, the network address that uniquely localizes the AMT server on the AMT PC must be entered.

If DHCP is set for the automatic assignment of the network address in "Network Setup" in the MEBx of the AMT PC, the network address is not fixed.

Procedure

If the AMT server uses the same network address as the operating system of the AMT PC (most common situation):

1. You can obtain the address of the AMT server in the command line in Windows using "ipconfig" and in UNIX using "ifconfig".

If the AMT server and operating system do not use the same network address, ask your network administrator for the address you have been assigned.

8.7.7 Forcing user consent

When a connection to the AMT PC is established, the KVM viewer may prompt the user to enter a six-figure code. This code is displayed on the screen of the AMT PC. The user of the AMT PC must inform the user of the KVM viewer of this code.

This code query needs to be set up on the KVM viewer.

Procedure

1. Select "Intel(R) AMT Configuration > User Consent" in the MEBx.
2. Select the value "KVM" for "User Consent".

To allow a user with administrator privileges to avoid this code query, follow these steps:

1. Select "Intel(R) AMT Configuration > User Consent" in the MEBx.
2. Select "Opt-in Configurable from Remote IT".

8.8 Assignment of expansion interface to the software in the TIA Portal (CP assignment)

The table below shows the correlation between enclosure labeling of the IPC expansion slots and the labeling that is used during assignment of interfaces to the software in the TIA Portal.

Enclosure labeling	TIA Portal
1	X100
2	X101
3	X102
4	X103
5	X104
6	X105
7	X106

Technical support

A.1 Service and support

You can find additional information and support for the products described on the Internet at the following addresses:

- Technical support (<https://support.industry.siemens.com>)
- Support request form (<http://www.siemens.com/automation/support-request>)
- After Sales Information System SIMATIC IPC/PG (<http://www.siemens.com/asis>)
- SIMATIC Documentation Collection (<http://www.siemens.com/simatic-tech-doku-portal>)
- Your local representative
(<http://www.automation.siemens.com/mcms/aspa-db/en/Pages/default.aspx>)
- Training center (<http://sitrain.automation.siemens.com/sitrainworld/?AppLang=en>)
- Industry Mall (<https://mall.industry.siemens.com>)

When contacting your local representative or Technical Support, please have the following information at hand:

- MLFB of the device
- BIOS version for industrial PC or image version of the device
- Other installed hardware
- Other installed software

Tools & downloads

Please check regularly if updates and hotfixes are available for download to your device. The download area is available on the Internet at the following link:

After Sales Information System SIMATIC IPC/PG (<http://www.siemens.com/asis>)

A.2 Troubleshooting

This chapter provides you with tips on how to locate and/or troubleshoot problems which occur.

Problem	Cause	Remedy
The device is not operational	No power supply	<ul style="list-style-type: none"> • Check the power supply, the power cable and the power plug. • Check to see if the on-off switch is in the correct position.
	Device is being operated outside the specified ambient conditions	<ul style="list-style-type: none"> • Check the ambient conditions. • After transport in cold weather do not turn the power on until after a waiting period of approximately 12 hours.
The monitor remains dark	The monitor is switched off	Switch on the monitor.
	The monitor is in "power save" mode	Press any key on the keyboard.
	The brightness button has been set to dark	Increase brightness using the brightness button. Detailed information can be found in the operating manual for the monitor.
	The power cord or the monitor cable is not connected.	<ul style="list-style-type: none"> • Check if the power cord is properly connected to the monitor and to the system unit or to the grounded shockproof power outlet. • Check to make sure the monitor cable is properly connected to the system unit and the monitor. <p>Contact your technical support team if the screen still remains dark after all these controls and measures.</p>
The mouse pointer does not appear on the screen	The mouse driver is not loaded	Check whether the mouse driver is properly installed and available when you start the user program. Detailed information about the mouse driver is available in the corresponding documentation.
	Mouse not connected	<ul style="list-style-type: none"> • Check to make sure that the mouse cable is properly connected to the system unit. • If you use an adapter or extension cable for the mouse cable make sure to check these connections as well. <p>Contact your technical support team if the mouse pointer still does not appear on the screen after these controls and measures.</p>
Time and/or date of the PC is not correct		<ol style="list-style-type: none"> 1. Press <F2> during the booting process to open the BIOS Setup. 2. Set the time and date in the setup menu.

Problem	Cause	Remedy
Although the BIOS setting is OK, the time and data are still wrong	The backup battery is dead.	Replace the backup battery.
USB device not responding	USB ports are deactivated in the BIOS Setup	Use a different USB port or activate the port.
	Operating system does not support XHCI	Activate the "PS/2 Emulation" setup parameter in the "Advanced > USB Configuration" menu of the BIOS Setup.
	USB-2.0/3.0 device connected although USB-2.0/3.0 is deactivated	Activate the USB.
	Operating system does not support the USB interfaces	<ul style="list-style-type: none"> • Activate the "Legacy USB Support" setup parameter in the "Advanced > USB Configuration" menu of the BIOS Setup. • For other devices, you need the USB device drivers for the required operating system.
DVD drive does not open	The device is switched off or the open/close button is disabled by a software application.	<p>Emergency removal of the data medium:</p> <ol style="list-style-type: none"> 1. Switch off the device. 2. Insert a pointed object such as a straightened paper clip into the emergency eject opening of the drive and press gently until the front loader opens. 3. Use your hand to pull the loader out further.

A.3 RAID system and device startup

Problem	Cause	Remedy
The RAID software reports the following errors: <ul style="list-style-type: none"> • The RAID plug-in failed to load, because the drive is not installed. • The Serial ATA plug-in failed to load, because the driver is not installed correctly. • The Intel® Storage Console was unable to load a page for the following reason: <ul style="list-style-type: none"> – A plug-in did not provide a page for the selected device – A plug-in failed to load 	RAID is not activated	The messages have no negative effect on the operation of the device and can be ignored. Acknowledge the messages.
	RAID is activated	Install the software again using the supplied "Documentation and Drivers" DVD.
After changing the drive, the system does not boot from the RAID system	RAID system does not have highest boot priority	BIOS setup, Boot menu: <ul style="list-style-type: none"> • Permit RAID system in the boot priority • Give RAID system top boot priority
After changing the drive, "Unused" is indicated for the relevant SATA port	System was booted without functioning drive. The removable tray might not be fully pushed in.	Reboot the system with a functioning hard disk.
Computer does not boot or "Boot device not found" is displayed	The boot medium is not approved	Allow the boot device in the boot priority in the "Boot" menu of the BIOS Setup.
	The boot device is not in first place of the boot priority in the BIOS setup	Change the boot priority of "Boot device" in the "Boot" menu of the BIOS Setup.
	The boot data carrier is set up with GPT and UEFI boot is deactivated in the BIOS setup	Activate UEFI boot in the BIOS Setup.
The startup of a Windows operating system on a GPT data carrier is aborted with the following error message: "Status: 0xc0000225 Info: The boot selection failed because a required device is inaccessible"	The boot parameters in the boot loader file "BCD" are incorrect or damaged.	Run "Startup and Repair" from Microsoft Windows: <ol style="list-style-type: none"> 1. Insert the Recovery DVD into the optical drive. 2. Select the line with "UEFI" in front of the name of the optical drive. 3. Click "Next" in the language selection window. 4. In the following "Install Windows" dialog, click "Repair your computer" or press the <R> key. The "System Recovery Options" dialog appears. The system is checked for errors. 5. Next, click "Repair and restart".

A.4 Notes on the use of expansion cards

Problem	Cause	Remedy
The device crashes during startup	<ul style="list-style-type: none"> • Redundant I/O addresses • Redundant hardware interrupts and/or DMA channels • Signal frequencies or signal levels are not adhered to • Different pin assignment 	<p>Check your computer configuration:</p> <ul style="list-style-type: none"> • If the computer configuration corresponds to the delivery state, contact your technical support team. • In the case of a change in the configuration, restore the delivery state. To do this, remove the expansion card and restart the device. If the error no longer occurs, the expansion card was the cause of the fault. Replace this with a Siemens expansion card or contact the supplier of the expansion card.
		If the device still crashes, contact your technical support team.
	Insufficient output of an external power supply, e.g., UPS	Use a powerful power supply.
The device does not start up or switches off immediately	A counter voltage is fed into the device by connected or installed expansion cards	<p>Clarify the following with the supplier of the component:</p> <ul style="list-style-type: none"> • The component can be operated without an external power supply. • The component can be reconfigured so that it only uses the external power supply or that of the device.

List of abbreviations

Abbreviation	Term	Meaning
AC	Alternating current	Alternating current
PLC	Programmable controller	
AGP	Accelerated Graphics Port	High speed bus system
AHCI	Advanced Host Controller Interface	Standardized controller interface for SATA devices. This is supported in Microsoft Windows XP as of SP1 and IAA driver.
APIC	Advanced Programmable Interrupt Controller	Extended programmable interrupt controller
AT	Advanced Technology	
ATA	Advanced Technology Attachment	
AWG	American Wire Gauge	US standard for the cable diameter
BIOS	Basic Input Output System	Basic Input Output System
CAN	Controller Area Network	
CD-ROM	Compact Disc – Read Only Memory	Removable storage medium for large data volumes
CD-RW	Compact Disc – Rewritable	Rewritable CD
CE	Communauté Européenne (CE symbol)	The product is in conformance with all applicable EC directives
CF	Compact Flash	
CMOS	Complementary Metal Oxide Semiconductors	Complementary metal oxide semiconductors
COA	Certificate of authentication	Microsoft Windows Product Key
COM	Communications Port	Term for the serial interface
CP	Communication Processor	Communication computer
CPU	Central Processing Unit	CPU
CRT	Cathode Ray Tube	
CSA	Canadian Standards Association	Canadian organization for tests and certifications according to own or bi-national standards (with UL / USA) standards
DRAM	Dynamic Random Access Memory	
DMA	Direct Memory Access	Direct memory access
DOS	Disk Operating System	Operating system without GUI
DVD	Digital Versatile Disk	
DVI	Digital Visual Interface	Digital display interface
DVI-I	Digital Visual Interface	Digital display interface with digital and VGA signals

Abbreviation	Term	Meaning
ECP	Extended capability port	Extended parallel port
EFI	Extensible Firmware Interface	
ESD	Components sensitive to electrostatic charge	
EN	European standard	
EPP	Enhanced Parallel Port	Bi-directional Centronics interface
HD	Hard Disk	Hard disk
HDD	Hard Disk Drive	Hard disk drive
HU	Height unit	
HT	Hyper Threading	
I/O	Input/Output	Data input/output on computers
IAA	Intel Application Accelerator	
IDE	Integrated Device Electronics	
IEC	International Electrical Commission	
IP	Ingress Protection	Degree of protection
IRQ	Interrupt Request	Interrupt request
ISA	Industry Standard Architecture	Bus for expansion card
LAN	Local Area Network	Computer network that is limited to a local area.
LCD	Liquid Crystal Display	Liquid crystal display
LED	Light Emitting Diode	Light emitting diode
LPT	Line Printer	Printer port
MAC	Media access control	Media access control
MLFB	Machine-readable product designation	
MUI	Multilanguage User Interface	Language localization in Windows
NEMA	National Electrical Manufacturers Association	Syndicate of manufacturers of electrical components in the USA
NTFS	New Technology File System	Secure file system for Windows versions (2000, XP, 7)
OPC	OLE for Process Control	Standardized interface for industrial processes
PC	Personal computer	
PCI	Peripheral Component Interconnect	High-speed expansion bus
PCIe	Peripheral Component Interconnect express	High-speed serial, differential full-duplex PtP interface with high data rate.
PFC	Power Factor Correction	Harmonic suppression for operation on public networks.
PG	Programming device	
PIC	Programmable Interrupt Controller	Programmable interrupt controller
PXE	Preboot Execution Environment	Software for running new PCs without drive data via the network
RAID	Redundant Array of Independent Disks	Redundant drive array
RAM	Random Access Memory	

Abbreviation	Term	Meaning
ROM	Read-Only Memory	
SDRAM	Synchronous DRAM	
SJT	Service [Grade] Junior (Hard Service) Thermoplastic	PVC armored cable
SNMP	Simple Network Management Protocol	Network protocol
SSD	Solid State Drive	
UEFI	Unified Extensible Firmware Interface	
UL	Underwriters Laboratories Inc.	US organization for tests and certifications according to own or binational standards (with CSA / Canada) standards
URL	Uniform Resource Locator	Designation of the full address of an Internet page
USB	Universal Serial Bus	
V.24		ITU-T standardized recommendation for data transfer via serial ports
VDE	Verband der Elektrotechnik Elektronik Informationstechnik e.V	since 1998: Verband der Elektrotechnik Elektronik Informationstechnik e.V formerly: Verband Deutscher Elektro- techniker
VGA	Video Graphics Array	Video adapter which meets industrial standard
VT	Virtualization Technology	Intel technology with which a virtually closed environment can be made avail- able
WD	Watchdog	Program monitoring with error detection and alarming









Markings and symbols

C.1 Overview



The following tables show all the symbols which may be found on your SIMATIC industrial PC, SIMATIC industrial monitor or SIMATIC Field PG in addition to the symbols which are explained in the operating instructions.

The symbols on your device may vary in some details from the symbols shown in the following tables.





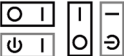













C.2 Safety

Symbol	Meaning	Symbol	Meaning
	Warning, observe the supplied documentation.		Lock is closed
	Attention, radio equipment		Lock is open
	Disconnect the power plug before opening		Opening for Kensington lock
	Attention ESD (Electrostatic sensitive device)		Warning of hot surface

C.3 Operator controls

Symbol	Meaning	Symbol	Meaning
	On/off switch, without electrical isolation		Eject CD/DVD
	On/off switch, without electrical isolation		

C.4 Interfaces

Symbol	Meaning	Symbol	Meaning
	Connection to the power supply		PS/2 mouse interface
	Protective conductor terminal		PS/2 keyboard-interface
 	Connection for functional earthing (equipotential bonding line)		Multimedia Card Reader
DPP	DisplayPort interface		Smart Card Reader
	DVI-D interface		Line In
LAN 	LAN interface, not approved for connecting WAN or telephone		Line Out
	Serial port		Microphone input
	USB port		Universal Audio Jack
	USB 2.0 high-speed port		Headphone output
	USB 3.0 super-speed port		

Glossary

APIC mode

Advanced peripheral interrupt controller. 24 interrupt lines are available.

Automation system

A programmable controller (PLC) of the SIMATIC S7 system consist of a central controller, one or several CPUs, and various I/O modules.

BIOS Setup

A program in which information about the device configuration (that is the configuration of the hardware on the PC/PG) is defined. The device configuration of the PC/PG is preset with defaults. Changes must be made if a memory expansion, new expansion card or drives are to be activated.

Cache

High-speed access buffer for interim storage (buffering) of requested data.

Card retainer

The card retainer is used to fasten expansion cards and ensure safe contact and transport. Large, heavy expansion cards are particularly affected by shocks and vibrations. We therefore recommend that you use the card retainer for this type of expansion card. Very short, compact and light expansion cards are also available on the market. The card retainer was not designed for these expansion cards because standard fastening is sufficient for them.

CE marking

CE stands for Communauté Européenne. The CE symbol confirms the conformity of the product with all applicable EC directives such as the EMC Directive.

Chipset

The chipset sits on the motherboard and connects the processor to the RAM, the graphics card, the PCI bus and the external interfaces.

Configuration files

These are files containing data which define the configuration after restart. Examples of such files are CONFIG.SYS, AUTOEXEC.BAT and the registry files .

Controller

Integrated hardware and software controllers that control the functions of certain internal or peripheral devices (for example, the keyboard controller).

Device configuration

The configuration of a PC or programming device contains information on hardware and device options, such as memory configuration, drive types, monitor, network address, etc. The data are stored in a configuration file and enable the operating system to load the correct device drivers and configure the correct device parameters. . If changes are made to the hardware configuration, the user can change entries in the configuration file using the SETUP program.

Disc-At-Once

With this burning technique, data are written to a CD in a single session, and the CD is then closed. Further write access is then no longer possible.

DisplayPort

DisplayPort is a VESA standardized, universal and license-free connection standard for the transmission of image and sound signals. Areas of application are mainly the connection of screens and TVs to computers, DVD players and similar devices.

Drivers

Program parts of the operating system. They adapt user program data to the specific formats required by I/O devices such as hard disks, printers, and monitors.

DVD

The DVD (short for: Digital Versatile Disc; English for: Digital Versatile Disc) is a digital optical storage medium, like a CD, but with a larger capacity. R "Recordable" stands for writable once, RW "Rewritable" means you can rewrite the DVD up to approximately 1000 times.

Energy options

The energy options can be used to reduce energy consumption of the computer, while keeping it ready for immediate use. This can be configured in Windows by selecting Settings > Control Panel > Energy options.

Ethernet

Local network (bus structure) for text and data communication with a transfer rate of 10/100/1000 Mbps.

Expansion card

Expansion cards are plug-in units for PLCs, programming devices or PCs. They are available as central modules, interface modules or mass storage (mass storage modules).

Extensible Firmware Interface

Refers to the central interface between the firmware, the individual components of a computer and the operating system. EFI is located logically beneath the operating system and represents the successor to PC BIOS, focusing on 64-bit systems.

Image

This refers to the image, for example, of hard disk partitions saved to a file in order to restore them when necessary.

Intel Active Management Technology

This technology permits the diagnostics, management and remote control of PCs. It is only effective when all relevant system components, such as processors, operating systems and applications are supported.

Interface

See Interface

- Physical interconnection (cable) of hardware elements such as PLCs, PCs, programming devices, printers or monitors.
- Interface for interactive software applications.

Interface

See Interface

- Physical interconnection (cable) of hardware elements such as PLCs, PCs, programming devices, printers or monitors.
- Interface for interactive software applications.

Interface, multi-point

MPI is the programming interface of SIMATIC S7/M7. Allows remote access to programmable modules, text-based displays and OPs from central locations. The MPI nodes can intercommunicate.

LAN

LAN is a local network that consists of a group of computers and other devices that are distributed across a relatively restricted range and are linked with communication cables. The devices connected to a LAN are called nodes. The purpose of networks is the mutual use of files, printers or other resources.

License key

The license key represents the electronic license stamp of a license. Siemens AG issues a license key for each software that is protected by a license.

Motherboard

The motherboard is the core of the computer. Here, data are processed and stored, and interfaces and device I/Os are controlled and managed.

Operating system

Generic term which describes all functions for controlling and monitoring user program execution, distribution of system resources to the user programs and the operating mode in cooperation with the hardware (for example Windows XP Professional).

Packet writing

The CD-RW is used as a disk medium. The CD can then be read only by packet writing compatible software or has to be finalized. Finalization of a CD closes the CD within an ISO9660 shell. You can still write to the CD-RW several times in spite of finalization. Not all CD drives can read packet-written CDs. There are restrictions to using this method in general data transfer.

PCIe

PCI-Express (Peripheral Component Interconnect Express) is an extension standard for connection of I/O devices with the chipset of a main processor. PCIe is the successor of PCI, PCI-X and AGP and offers a higher data transmission rate in comparison to its predecessors.

PIC mode

Peripheral interrupt controller. 15 interrupt lines are available.

PROFIBUS, MPI

Process Field Bus (standard bus system for process applications)

PROFINET

PROFINET is the name of the standard for Industrial Ethernet developed and maintained by the PROFIBUS user organization. PROFINET unites protocols and specifications with which Industrial Ethernet meets the requirements of industrial automation technology.

Programmable controller

The programmable controllers of the SIMATIC S5 system consist of a central controller, one or more CPUs, and I/O modules, for example.

Recovery DVD

Contains the tools for configuring hard disks and the Windows operating system.

Reset

Hardware reset: Reset/restart of the PC using a button/switch.

Restart

Warm restart of a computer without switching the power off (Ctrl + Alt + Del)

Restore DVD

The Restore DVD is used to restore the system partition or the entire hard disk to factory state if the system has crashed. The DVD contains all the necessary image files and is bootable.

S.M.A.R.T

SMART or S.M.A.R.T. (Self-Monitoring, Analysis and Reporting Technology) is an industry standard that is installed in storage media. It makes for permanent monitoring of important parameters and early detection of imminent problems.

SATA

Serial ATA Interface for hard disk drives and optical drives with serial data transmission rates of up to 300 Mbps.

Session-At-Once

In session-at-once, the CD can be written to both with an audio session and a data session. The two sessions are written to at once (as in disc-at-once).

Solid State Drive

A Solid State Drive is a drive that can be installed like any other drive; it does not contain a rotating disk or other moving parts because only semiconductor memory chips of similar capacity will be used. This design makes SSDs more rugged, provides shorter access times, low energy consumption and rapid data transfer.

Track-At-Once

In track-at-once recording, a CD can be written to in bits in several sessions if the CD was not closed.

Wake on LAN

Wake on Local area network. This function allows the PC to be started via the LAN interface.

Index

2

2 HDD system, (See System with two drives)

5

5.25" drive
Installing, 84

A

Access protection, 28
AHCI controller
 Making known to the operating system,
 (See storage controllers)
Alarm reset button, 20
Angle brackets, 35
Antivirus software, 52
Approval, (See EAC)
Approvals, 30
Australia, 126
Authorization, 121
Automatic Update, 52

B

Backup battery, 58
 Maintenance interval, 90
Basic data, 11
Battery monitoring, 58

C

Cabinet manufacturer, 35
Canada, 125
CE marking, 126
Certificates, 126
 Approvals, 125
COA label, 32
COM interface
 Technical specifications, 136
COM1
 Connection, 17

COM2

 Connection, 17
Component label, 33
Components sensitive to electrostatic charge, 127
Condensation, 32
Connecting
 Equipotential bonding, 38
 I/O devices, 37
 Power supply, 42
Connection for functional earthing, 38
Connection of equipotential bonding, 38
Connections, (See Interfaces)
Country-specific information, 39

D

Data carrier controller
 Making known to the operating system, 114
Data exchange, 43
Degree of protection, 132
Device configuration, 144
Device fan, 99, 101
 Maintenance interval, 90
 Removing and installing, 99, 101
DiagMonitor, 14
 Temperature monitoring, 56
Dimension drawings, 129
Directive
 ESD Directive, 127
DisplayPort
 Connection, 17
Documentation and Drivers CD/DVD, 111
Drive cage
 Removal, 72
Drivers
 Installing, 112
Drives
 Maintenance interval, 90
 Mounting locations, 12
 Technical specifications, 134
Dust protection, 132
DVD drive
 Removing and installing, 87
DVI-D
 Connection, 17, 18
DVI-I
 Connection, 18

- E**
 - EAC, 126
 - EC Declaration of Conformity, 126
 - Electromagnetic compatibility, 126
 - for system expansions, 26
 - EMC, (See Electromagnetic compatibility)
 - ESD, 127
 - ESD Directive, 127
 - Ethernet, 43
 - Connection, 18
 - Status display, 22
 - Ethernet address, 33
 - Expansion cards
 - Installing, 69
 - Slots on motherboard, 135
 - Specification, 69
 - Types, 11
 - Expansions, 61, 62
- F**
 - Fan, (See Device fan)
 - Fan cover
 - Location of filter pad, 91
 - Open, 90
 - FCC, 125
 - Filter, (See Filter pad)
 - Filter pad
 - Changing, 91
 - Maintenance interval, 90
 - Fire protection, 34
 - Fire protection housing, 34
 - Firewall, 52
 - Front panel, (See Fan cover)
 - Configuration, 14
 - FS, (See Manufacturing version)
- G**
 - Graphic controller, 136
 - Graphics card, 136
 - Graphics memory, 136
- H**
 - Hard disk
 - installing from the removable tray, 75
 - installing in the removable tray, 75
 - removing from the removable tray, 74
 - Hard disk drive
 - Second hard disk drive, (See System with two drives)
 - Hardware reset, 54
 - Highlights, 10
 - Hot spare drive, 51
- I**
 - I/O devices
 - Connecting, 37
 - Identification data, 32
 - Image & Partition Creator, 14
 - Initial commissioning, 45
 - Inrush current
 - Redundant power supply, 140
 - Single power supply, 139
 - Inserting a hard disk drive or SSD, 76
 - Installation
 - 5.25" drive, 84
 - Expansion cards, 69
 - Mounting locations, 35
 - Mounting methods, 35
 - Installation information, 34
 - Installing
 - Hard disk drive or SSD, 76
 - Windows, 113
 - Installing language package, (See MUI)
 - Integration
 - Ethernet, 43
 - PROFINET, 44
 - Interface
 - COM1, 17
 - COM2, 17
 - DVI-D, 17, 18
 - DVI-I, 18
 - Ethernet, 18
 - LPT, 18
 - USB 2.0, 17, 18
 - USB 3.0, 18
 - VGA, 18
 - Interfaces
 - On the device rear, 17
 - Parallel, 136
 - IT communication, 43
- L**
 - Labeling, 126
 - Korea, 126
 - LAN, (See Ethernet)

LEDs, (See Status displays)
 License key, 121
 Limitation of liability, 61, 89
 LPT
 Connection, 18
 LPT1, 136

M

Main memory, 135
 Manufacturing version
 of the device, 33
 Marking
 EC Declaration of Conformity, 126
 Memory modules
 Slots on motherboard, 135
 Modules, (See Expansion cards)
 Monitoring
 Fan, 56
 Temperature, 56
 Monitoring functions
 Overview, 13, 55
 Motherboard, (See motherboard)
 Removal, 106
 Mounting holes, 35
 MUI, 119
 Multi-monitoring, 44

N

NCQ, 134
 New Zealand, 126
 Note, 34
 Installation guidelines, 34

O

On/off button, 20
 On/off switch
 Basic power supply, 20
 Redundant power supply, 20
 Open
 Device, 68
 Open the device, 68
 Operating system, 13
 Initial commissioning, 45
 Installing, 113
 Shutdown, 53
 Updates, 111
 Operator controls, 20

Overview
 Drive cage, 12

P

Package contents, 31
 Checking, 31
 Packaging, 31
 Checking, 31
 Removing, 31
 Partitions
 Setting up, 114
 Windows 10, 118
 Windows 7, 118
 Windows Server 2008, 118
 Windows Server 2012, 118
 Power consumption, 131
 Power plug latch, 41
 Power requirements, 138
 Power supply
 basic, 11
 Connecting, 39
 Connecting a single power supply, 40
 Redundant, 11
 Redundant power supply: (See Inrush current)
 Redundant: (See Connection)
 Redundant: (See Removal)
 Single power supply: (See Inrush current)
 Single: (See Connection)
 Single: (See Removal)
 Processor, 135
 Changing, 108
 Product version
 of the device, (See Manufacturing version)
 PROFIBUS
 Integration, 43
 PROFINET, 44
 Protection class, 30, 132
 Protective measure
 Static electricity, 128

R

Radiation, 27
 High frequency radiation, 27
 RAID, 154
 RAID controller
 Making known to the operating system, (See storage controllers)
 RAID system
 Automatic integration of new hard disk, 95

- Checking status, 93
- Displaying the defective HDD in the RAID software, 94
- Integrating hot-spare drive, 98
- Management functions, 50, 93
- Management functions, 50, 93
- Manual integration of new hard disk, 96
- RAID1 system, 51
 - Mounting locations for hard disk drives, 81
 - Replacing a defective hard disk drive, 84
 - Status displays of the hard disk drives, 82
- RAID1 system with hot spare drive, 51
- RAID5 system, 51
 - Detecting a defective hard disk drive, 83
 - Mounting locations for hard disk drives, 83
 - Replacing a defective hard disk drive, 84
 - Status displays of the hard disk drives, 84
- RAID5 system with hot spare drive, 51
- Rating plate, 32
- Rear of the device
 - Configuration, 16
- Recovery DVD, 111
- Removable hard disk, 48
- Removal
 - Device fan, 99, 101
 - Drive cage, 72
 - DVD drive, 87
 - Motherboard, 106
 - Processor, 108
 - Redundant power supply, 104, 105
 - Single power supply, 103
- Repairs, 89, 90
- Reset button, 20
- Restore DVD, 111
- Restoring the factory state, 121

S

- Safety information
 - Storage, 32
 - Transportation, 32
- Serial number, 33
- SIMATIC NET, 44
- SIMATIC S7, 43
 - Integration, 43
- SIMATIC software
 - Installing, 112
- Slave drive, (See System with two drives)
- Software
 - Installing, 112
- Static electricity
 - Protective measures, 128

- Status displays, 21
 - Ethernet interface, 22
- Status indicators, (See Status displays)
- Strain relief
 - Ethernet cable, 43
- Supply voltage, 39, 131
- Switching off the device
 - Disconnect from mains voltage, 53
 - Forced shutdown, (See Hardware reset)
 - Hardware reset, 54
 - Shutting down the operating system, 53
- Switching on the device
 - Configure automatic startup, 46
 - Switching on for the first time, 45
- System partition, 121
- System resources, 141
- System with two drives, 49

T

- Technical specifications, 131
- Telescopic rails, 35
 - Technical specifications (basic configuration), 140
- Temperature monitoring, 56
- Tools, 62, 90

U

- UL approval, 125
- Update, 52
- Updates
 - Operating system, 111
- USB 2.0
 - Connection, 17, 18
- USB 3.0
 - Connection, 18
- User Account Control, 52

V

- Ventilation slots, 30, 34
- VGA
 - Connection, 18

W

- Warranty, 26
- Watchdog, 13, 57
 - Monitoring function, 57
 - Monitoring times, 58
- Windows
 - Installing, 113
 - Partitions, 118
- Windows Action Center, 52